

# *creative* knitting

## 36

Inspiring  
patterns!

Heaps of Winter  
Ideas for the  
whole family

Knits for  
babies and  
toddlers

**PLUS**

Amazing Knitting  
Ideas for you to Create

Beanies, scarves, jumpers, tops and more

**FULL OF TIPS AND TECHNIQUES**



8



12



20



64

# CONTENTS



## WOMEN

*Luxurious knits to keep ladies warm*

- 4 Lace Top
- 7 Open Mesh Hat And Scarf
- 8 Stripe Texture Cardigan
- 12 Cable Wrap And Hat
- 16 Family Beanie
- 30 Anne Marie
- 34 Hat And Fingerless Gloves
- 36 Sweater Dress
- 38 Fitting Short Vest
- 40 Mohair Socks
- 52 Cardigan With Eyelet Pattern
- 54 Garter Stitch Shawl-Vest
- 56 Somerville Sweater
- 58 Aran Beanie
- 60 Juniper Sweater and Partridge Scarf
- 62 Hat And Buttoned Short Scarf
- 64 Christina Scarf

## KIDS *Adorable and fun knits from babies and teens*

- 20 Baby's Jumper And Hat
- 24 Three Hats And One Scarf
- 26 Easy Raglan Pullover
- 28 Garter Stitch Jacket With Hood
- 44 Easy Jumper
- 46 Lucy Lou
- 49 Top Knot Beanie
- 50 Striped Hoodie
- 51 Little Cotton Hat



## MEN

*Knits that even he will love!*

- 20 Striped Scarf In Rib





## SKILL LEVEL



advanced

## WHAT YOU'LL NEED

### Yarn

6, 7 balls 65gm  
Cleckheaton Superfine

### Needles and tools

3.75mm circular knitting  
needles  
4.00mm circular  
knitting needles  
Cable needle  
Stitch holder

### Tension

As per cleckheaton  
superfine.

### Special abbreviations

Ssk – slip 2sts knitwise  
one at a time from the  
LH needle to the RH  
needle, insert LH needle  
through both front loops  
and knit together.

C4B – slip 2 sts onto  
a cable needle, hold at  
back, K2, K2 from cable  
needle

C4F – slip 2 sts onto a  
cable needle, hold at  
front, K2, K2 from cable  
needle.

SSM – slip stitch  
marker

# LACE TOP

*A delicate lace and cable pattern in a more advanced knit.*

## GETTING STARTED

Use a stitch marker placed at the end of each round to identify next round. Slip stitch marker at the end of each round.

## WORKING PATTERN

Sleeve edging (work both at same time).

Using 4.00mm needle cast on 51sts.

**Row 1:** edge – knit

**Row 2:** edge – knit

**Row 3:** edge eyelets – K2, (yo, K2tog) to last st, K1.

**Row 4:** edge – knit

Leave sts on a holder.

## MAIN BODY

Using 4.00mm needle cast on 230(276) sts.

**Row 1:** edging – knit, place stitch marker.

**Row 2:** edging – purl, slip stitch marker (ssm).

**Row 3:** edging eyelet – (yo, K2tog) to end.

**Row 4:** edging – purl.

Change to 4.00mm needles and work 32 rounds in lace and rev st st patt as follows:

### Lace rounds

**Round 1:** (P7, yo, K3, ssk, K6, K2tog, K3, yo) 10 (12) times.

**Round 2:** (P7, K16) 10 (12) times.

**Round 3:** (P7, K1, yo, K3, ssk, K4, K2tog, K3, yo, K1) 10 (12) times.

**Round 4:** (P7, K16) 10 (12) times.

**Round 5:** (P7, K2, yo, K3, ssk,

K2, K2tog, K3, yo, K2) 10 (12) times.

**Round 6:** (P7, K16) 10 (12) times.

**Round 7:** (P7, K3, yo, K3, ssk, K2, K2tog, K3, yo, K3) 10 (12) times.

**Round 8:** (P7, K16) 10 (12) times.

**Round 9:** decrease – (P2tog, P3, P2tog, yo, K2, ssk, K6, K2tog, K3, yo) 10 (12) times. 210 (252) sts.

**Round 10:** (P5, K16) 10(12) times.

**Round 11:** (P5, K1, yo, K3, ssk, K4, K2tog, K3, yo, K1) 10 (12) times.

**Round 12:** (P5, K16) 10 (12) times.

**Round 13:** (P5, K2, yo, K3, ssk, K2, K2tog, K3, yo, K2) 10 (12) times.

**Round 14:** (P5, K16) 10 (12) times.

**Round 15:** (P5, K3, yo, K3, ssk, K2tog, K3, yo, K3) 10 (12) times.

**Round 16:** (P5, K16) 10(12) times.

**Round 17:** decrease – (P2tog, P1, yo, K3, ssk, K6, K2tog, K3, yo) 10 (12) times. 190 (228) sts.

**Round 18:** (P3, K16) 10 (12) times.

**Round 19:** (P3, K1, yo, K3, ssk, K4, K2tog, K3, yo, K1) 10 (12) times.

**Round 20:** (P3, K16) 10 (12) times.

**Round 21:** (P3, K2, yo, K3, ssk, K2, K2tog, K3, yo, K2) 10 (12) times.

## MEASUREMENTS

FINISHED FIT	77.5	92.5CM
GARMENT LENGTH	48.5	48.5CM

**Round 22:** (P3, K16) 10 (12) times.

**Round 23:** (P3, K3, yo, K3, ssk, K2tog, K3, yo, K3) 10(12) times.

**Round 24:** (P3, K16) 10 (12) times.

**Round 25:** decrease – (P3tog, yo, K3, ssk, K6, K2tog, K3, yo) 10 (12) times.

**Round 26:** (P1, K16) 10 (12) times.

**Round 27:** (P1, K1, yo, K3, ssk, K4, K2tog, K3, yo, K1) 10 (12) times.

**Round 28:** (P1, K16) 10 (12) times.

**Round 29:** (P1, K2, yo, K3, ssk, K2, K2tog, K3, yo, K2) 10 (12) times.

**Round 30:** (P1, K16) 10 (12) times.

**Round 31:** (P1, K3, yo, K3, ssk, K2tog, K3, yo, K3) 10 (12) times.

**Round 32:** (P1, K16) 10 (12) times.

Change to 3.75mm needle and work 26 round in cable and rib patt setting st as follows:

### Cable rounds

**Round 1, 2, 3 and 4:** (P1, K2, P2, K8, P2, K2) 10 (12) times.

**Round 5:** (P1, K2, P2, C4B, C4F, P2, K2) 10 (12) times.

**Round 6, 7 and 8:** (P1, K2, P2, K8, P2, K2) 10 (12) times.

The last 4 round form the cable patt rep.





Work cable rounds 5 and 6 once more.

Beg with a K row work in stocking st only until work measures 33cm from cast on edge.

**Next Round:** knit.

**Next Round:** purl.

**Next Round:** eyelets – (yo, K2tog) to end.

#### Armhole shaping

**Next Round:** P68 (85) cast off 17sts (1 pattern repeat) P68 (85), cast off 17sts (1 pattern repeat) 136 (170) sts.

#### Yoke shaping

**Round 1:** (P1, yo, K3, ssk, K6, K2tog, K3, yo) 4 (5) times with RS facing of 1st sleeve edging (P1, yo, K3, ssk, K6, K2tog, K3, yo) 3 times, (P1, yo, K3, ssk, K6, K2tog, K3, yo) 4 (5) times, with RS facing of 2nd sleeve edging (P1, yo, K3, ssk, K6, K2tog, K3, yo) 3 times. 238 (272) sts.

**Round 2:** (P1, K16) 14 (16) times.

**Round 3:** (P1, K1, yo, K3, ssk, J4, K2tog, K3, yo, K1) 14 (16) times.

**Round 4:** (P1, K16) 14 (16) times.

**Round 5:** (P1, K2, yo, K3, ssk, K2, K2tog, K3, yo, K2) 14 (16) times

**Round 6:** (P1, K16) 14 (16) times.

**Round 7:** (P1, K3, yo, K3, ssk, K2tog, K3, yo, K3) 14 (16) times.

**Round 8:** purl.

**Round 9:** eyelets – (yo, K2tog) to end.

**Round 10:** purl.

These 10 rounds for the yoke patt.

Work these 10 round 3 times more.

Work yoke decrease as follows:

**Round 41:** (P1, yo, ssk, K1, ssk, K6, K2tog, K1, K2tog, yo) 14 (16) times. 210 (240) sts.

**Round 42:** (P1, K14) 14 (16) times.

**Round 43:** decrease – (P1, K1, yo, ssk twice, K4, K2tog twice, yo, K1) 14 (16) times. 182 (208) sts.

**Round 44:** (P1, K12) 14 (16) times.

**Round 45:** decrease – (P1, K2, yo, ssk twice, K2tog twice, yo, K2) 14 (16) times. 154 (176) sts.

**Round 46:** (P1, K10) 14 (16) times.

**Round 47:** decrease – (P1, ssk, K1, yo, ssk, K2tog, yo, K1, K2tog) 14 (16) times. 126 (144) sts.

**Round 48:** purl.

**Next Round:** discard stitch markers (yo, K2tog) 63 (72) times.

**Next Round:** knit.

Change to 4.00mm needle, turn work and cast off knitwise on WS taking care not to pull stitches too tightly.

#### MAKING UP

Press or block to shape.

#### The Wool Inn

Shop 14 NK Centre  
450 High St, Penrith  
Ph: 02 4732 2201  
[www.the-wool-inn.com.au](http://www.the-wool-inn.com.au)



# OPEN MESH HAT AND SCARF

*Design by Wendy Wools*

## STITCH GUIDE

### OPEN MESH HAT

Using 12.00mm needles cast on 30 sts.

**Row 1:** (K3, P3) 5 times.

Rept this row 4 times more.

**Row 6:** Keeping rib pattern correct, inc in every 5th st. 36 sts.

**Row 7:** RS - K4, \*(yon) twice, K4, rept from \* to end.

**Row 8:** P2, P2tog, \*(P1, K1) into 2 yon (P2tog) twice.

Rept from \* to last 6 sts, (P1, K1) into 2 yon, P2tog, P2.

**Row 9:** K2, yon, \*K4, (yon) twice. Rept from \* to last 6 sts, K4, yon, K2.

**Row 10:** P2, P1 into yon, \*(P2tog) twice, P1, K1 into 2 yon, rept from \* to last 7 sts, (P2tog) twice, P1 into yon, P2.

Rept 7th to 10th rows twice, then 7th and 8th row once.

**Next Row:** (K2tog) till end.

**Next Row:** (P2tog) till end.

Draw yarn through rem sts, pull up and fasten off securely.

## MAKING UP

Join back seam by top sewing.

## SCARF

Using 15.00mm needles cast on 12 sts.

**Row 1:** P1, \* yon, P2tog, rept from \* to last st, P1.

Rept this row until work measures approx 200cm. Cast off.

## SKILL LEVEL



intermediate

## WHAT YOU'LL NEED

### Yarn

Hat: 1 ball 100gm

Wendy Pampas in shade 2255

Scarf: 3 balls 100gm

Wendy Pampas in shade 2255

### Needles

12.00mm knitting needles

15.00mm knitting needles

### Tension

Hat: 7.5 sts by 11.5 rows over st st on 12.00mm needles to 10 cm.

Scarf: tension is not important.

### Special abbreviations

yon - yarn over needle

## MEASUREMENTS

HAT TO FIT AVERAGE ADULT HEAD

SCARF LENGTH: 200CM

Wentworth Distributors NZ Ltd

Free phone AU: 1800 150 542

Free phone NZ: 0800 738 998

[www.naturallyyarnsnz.com](http://www.naturallyyarnsnz.com)



# STRIPE TEXTURE CARDIGAN

*8ply design using Cleckheaton California*

## STITCH GUIDE

**Note – This cardigan is worked on larger needles and at a looser tension than usually recommended for this yarn.**

## BACK

Using 5.50mm needles and C1, cast on 72 (80, 88, 96, 104) sts.

\*\* Work 3 rows garter st (first row is wrong side).

Change to 6.50mm needles.

## Beg Patt

**Note – Do not break off colour not in use, but carry loosely along side edge of work until needed again.**

Using C2, work 2 rows stocking st.

Using C1, work 2 rows garter st.

Last 4 rows form patt. \*\*

Work a further 90 rows patt.

## Shape Armholes

Keeping patt correct, cast

off 5 (6, 8, 9, 10) sts at beg of next 2 rows. 62 (68, 72, 78, 84) sts.

Dec one st at each end of next row, then in every foll alt row until 52 (56, 58, 62, 66) sts rem.

Work 35 (37, 37, 37, 39) rows.

## Shape Shoulders

Cast off 4 (4, 4, 5, 5) sts at beg of next 4 rows, then 3 (4, 4, 4, 5) sts at beg of foll 2 rows.

Cast off rem 30 (32, 34, 34, 36) sts.

## LEFT FRONT

Using 5.50mm needles and C1, cast on 37 (41, 45, 49, 53) sts.

Work as for Back from \*\* to \*\*.

Work a further 90 rows patt.

## Shape Armhole

Keeping patt correct, cast off 5 (6, 8, 9, 10) sts at beg of next row. 32 (35, 37, 40, 43) sts.

Dec one st at beg of every foll alt row until 27 (29, 30, 32, 34) sts rem.

Work 20 (20, 18, 16, 14) rows.

## Shape Neck

**Row 1:** Cast off 4 sts, patt to end.

**Row 2:** Patt to last 2 sts, work 2tog.

**Row 3:** As 1st row. 18 (20, 21, 23, 25) sts.

Dec one st at neck edge in next 3 rows, then in every foll alt row 3 (4, 5, 4, 4) times, then in every foll 4th row 0 (0, 0, 1, 2) times. 12 (13, 13, 15, 16) sts.

Work 3 rows.

## Shape Shoulder

**Next row:** Cast off 4 (4, 4, 5, 5) sts, patt to last 2 sts, patt 2tog.

Work 1 row.

Cast off 4 (4, 4, 5, 5) sts at beg of next row.

Work 1 row.

Cast off rem 3 (4, 4, 4, 5) sts.

## RIGHT FRONT

Using 5.50mm needles and C1, cast on 37 (41, 45, 49, 53) sts.

Work as for Back from \*\* to \*\*.

**Next row:** K2, K2tog, yfwd (buttonhole), knit to end.

Keeping patt correct, work 23 rows.

Rep last 24 rows twice, then buttonhole row once. 4 buttonholes.

Work 18 rows.

## SKILL LEVEL



intermediate

## WHAT YOU'LL NEED

### Yarn

3, 4, 4, 4, 4 balls 100gm Cleckheaton California 8ply in Colour 1 (C1) 6756 Regal  
3, 3, 4, 4, 4 balls 100gm Cleckheaton California 8ply in Colour 2 (C2) 8500 Forest

### Needles and tools

5.50mm knitting needles  
6.50mm knitting needles  
Wool sewing needle  
Plain yarn for sewing seams  
6 buttons

### Tension

15.5 sts by 26 rows over patt, on 6.50mm needles to 10cm

## MEASUREMENTS

SIZE	XS	S	M	L	XL
TO FIT BUST	70	80	90	100	110CM
FINISHED FIT	92	102	112	122	132CM
GARMENT LENGTH	55	56	57	58	59CM
SLEEVE LENGTH	45CM				





Cleckheaton



#### Shape Armhole

Keeping patt correct, cast off 5 (6, 8, 9, 10) sts at beg of next row. 32 (35, 37, 40, 43) sts.  
Dec one st at end of next row and foll alt row once. 30 (33, 35, 38, 41) sts.  
Work 1 row.

#### Next Row:

K2, K2tog, yfwd, patt to last 2 sts, K2tog.  
Dec one st at end of every foll alt row until 27 (29, 30, 32, 34) sts rem.  
Work 21 (21, 19, 17, 15) rows, at same time work a buttonhole (as before) in 24th row from

previous buttonhole.  
6 buttonholes in all.

#### Shape Neck

**Row 1:** Cast off 4 sts, patt to end.  
**Row 2:** Patt to last 2 sts, work 2tog.  
**Row 3:** As 1st row. 18 (20, 21, 23, 25) sts.  
Dec one st at neck edge in next 4 rows, then in every foll alt row 2 (3, 4, 3, 3) times, then in every foll 4th row 1 (1, 1, 2, 3) times. 11 (12, 12, 14, 15) sts.

#### Shape Shoulder

Cast off 4 (4, 4, 5, 5) sts at beg of next row and foll alt row.  
Work 1 row.  
Cast off rem 3 (4, 4, 4, 5) sts.

#### SLEEVES

Using 5.50mm needles and C1, cast on 34 (36, 38, 40, 42) sts.  
Work as for Back from \*\* to \*\*.  
Keeping patt correct, inc one st at each end of next row, then in every foll 18th (18th, 10th, 10th, 8th) row until there are 40 (42, 42, 56, 58) sts, then in every foll 20th (20th, 12th, 12th, 10th) row until there are 46 (48, 56, 60, 66) sts.  
Cont without further shaping until Sleeve measures 45cm from beg, working last row on wrong side.

#### Shape Top

Keeping patt correct, cast off 3 (3, 4, 4, 5) sts at beg of next 2 rows. 40 (42, 48, 52, 56) sts.  
Dec one st at each end of next row, then in foll 4th row once, then in every foll alt row until 26 (30, 32, 38, 38) sts rem, then in every row until 12 (12, 14, 16, 16) sts rem.

Cast off 2 sts at beg of next 2 rows.  
Cast off rem 8 (8, 10, 12, 12) sts.

#### FRONT EDGING

**Note – We recommend using mattress stitch and plain yarn to sew up your cardigan.**

Join shoulder seams. With right side facing, using 5.50mm needles and C1, knit up 82 sts evenly along one front edge.  
Work 2 rows garter st.  
Cast off loosely on wrong side.  
Rep edging on other front edge.

#### COLLAR

Using 6.50mm needles and C1, cast on 72 (74, 78, 82, 88) sts.  
Work 3 rows garter st (first row is wrong side).  
Work 24 rows patt as for Back.  
Using C1, cast off loosely.  
With RS of Collar facing, using 5.50mm needles and C1, knit up 18 sts evenly along one side edge.  
Work 2 rows garter st.  
Cast off loosely on wrong side.  
Rep along other side edge of collar.

#### MAKING UP

Do not press. Placing centre of collar to centre back neck and using a flat seam, sew cast off edge of collar to neck edge, beginning and ending 1cm inside front edge and easing any fullness into back neck.  
Placing centre of sleeve to shoulder seam, sew in sleeves evenly. Join side and sleeve seams, matching stripes. Sew on buttons.

#### Cleckheaton Yarns

1800 337 032

[www.cleckheaton.com.au](http://www.cleckheaton.com.au)

# STITCH 'N TIME



## QUALITY YARNS

- PATONS • SIRDAR • WENDY
- CLECKHEATON • JO SHARP
- HEIRLOOM • NATURALLY
- NATURAL & ITALIAN YARNS
- PATTERNS & ACCESSORIES

## READY MADE KNITWEAR

- KNITTING CLASSES
- Made to measure Orders Welcome
- HABERDASHERY
- TAPESTRIES • EMBROIDERY

**02 6282 8383**

2/55 Colbee Court Phillip ACT 2606



*The Yarn Queen*

New Zealand's dedicated online knitting store

### Stockists of:

- Filatura di Crosa • King Cole • Naturally
- Debbie Bliss • Twilleys of Stamford • Opal
- Misti Alpaca • Patons • Sirdar • Sublime
- Peter Pan • Shepherd • Wendy

*Luxury Yarns – Exclusive Designs*



[www.theyarnqueen.co.nz](http://www.theyarnqueen.co.nz)

[www.biggandesign.com](http://www.biggandesign.com)



**Premium First Cross  
4ply & DK Australian Merino  
in 64 Brilliant Colours**

# CABLE WRAP AND HAT

*A comfortable cable wrap with tie belt and shawl collar; add a cable hat to match*

## SKILL LEVEL

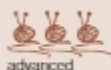

## WHAT YOU'LL NEED

### Yarn

Cable Jacket Version 1 (rust coloured cardigan): 15, 17, 17, 18 balls 50gm Jo Sharp Silkroad Aran Tweed in 113 Russet or Dusk 118  
Cable Jacket Version 2 (light coloured cardigan): 15, 17, 17, 18 balls 50gm Jo Sharp Silkroad Aran Tweed in 122 Beach  
Hat: 1 ball 50gm Jo Sharp Silkroad Aran Tweed in 121 Brindle or Dusk 118

### Needles

4.50mm knitting needles  
5.00mm knitting needles  
Cable needle

### Tension

18 sts by 24 rows of Stocking st on 5.00mm needles to 10cm. Cable Panel measures 10.5cm

### Special abbreviations

**T4L (Twist 4 Left)** - slip next 3 sts onto cable needle and hold at front of work, purl next st from left hand needle, then knit sts from cable needle.

**T4R (Twist 4 Right)** - slip next st onto cable needle and hold at back of work, knit next 3 sts from left hand needle, then purl st from cable needle.

**C6F (Cable 6 Front)** - slip next 3 sts onto cable needle and hold at front of work, knit next 3 sts from left hand needle, then knit sts from cable needle.

**C6B (Cable 6 Back)** - slip next 3 sts onto cable needle and hold at back of work, knit next 3 sts from left hand needle, then knit sts from cable needle.

**C4B or C4F (Cable 4 Back or Front)** - slip next 2 sts onto cable needle and hold at back (or front) of work, knit next 2 sts from left hand needle, then knit sts from cable needle.

**Hat: C6B (Cable 6 Back)** - slip next 3 sts onto cable needle and hold at back of

work, knit next 3 sts from left hand needle, then knit sts from cable needle.

### STITCH GUIDE

#### Cable 1 (4 sts)

**Row 1:** (RS) Knit.

**Row 2:** Purl.

**Row 3:** C4F.

**Row 4:** Purl. Repeat these 4 rows.

#### Cable 2 (4 sts)

**Row 1:** RS - Knit.

**Row 2:** Purl.

**Row 3:** C4B.

**Row 4:** Purl. Repeat these 4 rows.

#### Cable 3 (36 sts)

**Row 1:** RS - P6, T4L, T4R, p8, T4L, T4R, p6.

**Row 2:** K7, p6, k10, p6, k7.

**Row 3:** P7, C6F, p10, C6F, p7.

**Row 4:** As row 2.

**Row 5:** P6, T4R, T4L, p8, T4R, T4L, p6.

**Row 6:** K6, p3, k2, p3, k8, p3, k2, p3, k6.

**Row 7:** P5, T4R, p2, T4L, p6, T4R, p2, T4L, p5.

**Row 8:** K5, p3, k4, p3, k6, p3, k4, p3, k5.

**Row 9:** P5, k3, p4, T4L, p4, T4R, p4, k3, p5.

**Row 10:** K5, p3, k5, p3, k4, p3, k5, p3, k5.

**Row 11:** P5, T4L, p4, T4L, p2, T4R, p4, T4R, p5.

**Row 12:** K6, p3, k5, p3, k2, p3, k5, p3, k6.

**Row 13:** P6, T4L, p4, T4L, T4R, p4, T4R, p6.

**Row 14:** K7, p3, k5, p6, k5, p3, k7.

**Row 15:** P7, T4L, p4, C6B, p4, T4R, p7.

**Row 16:** K8, p3, k4, p6, k4, p3, k8.

**Row 17:** P8, (T4L, p2, T4R) twice, p8.

**Row 18:** K9, p3, (k2, p3) 3 times, k9.

**Row 19:** P9, T4L, T4R, p2, T4L, T4R, p9.

**Row 20:** K10, p6, k4, p6, k10.

**Row 21:** P10, C6F, p4, C6F, p10.

**Row 22:** As row 20.

**Row 23:** P9, T4R, T4L, p2, T4R, T4L, p9.

**Row 24:** As row 18.

**Row 25:** P8, (T4R, p2, T4L) twice, p8.

**Row 26:** As row 16.

**Row 27:** P7, T4R, p4, C6B, p4, T4L, p7.

**Row 28:** As row 14.

**Row 29:** P6, T4R, p4, T4R, T4L, p4, T4L, p6.

**Row 30:** As row 12.

**Row 31:** P5, T4R, p4, T4R, p2, T4L, p4, T4L, p5.

**Row 32:** As row 10.

**Row 33:** P5, k3, p4, T4R, p4, T4L, p4, k3, p5.

**Row 34:** As row 8.

**Row 35:** P5, T4L, p2, T4R, p6, T4L, p2, T4R, p5.

**Row 36:** As row 6. Repeat these 36 rows.

### LEFT FRONT

Using 4.50mm needles, cast on 58(60, 66, 72) sts. Work in k2, p2 rib for 4cm, ending on a WS row and inc 1 st each end last row worked 58(62, 68, 74) sts. Change to 5.00mm needles.

## MEASUREMENTS

SIZE	A	B	C	D
<b>TO FIT BUST</b>	<b>80</b>	<b>90</b>	<b>100</b>	<b>110CM</b>
FINISHED FIT	108	118	130	142CM
<b>GARMENT LENGTH</b>	<b>70</b>	<b>72</b>	<b>72</b>	<b>72CM</b>
SLEEVE LENGTH	44	44	46	46CM
<b>HAT ONE SIZE FITS ALL</b>				





**Establishment rows:**

**Row 1:** RS - P7 (9, 12, 15) sts, work row 1 Cable 1, work row 1 Cable 3, work row 1 Cable 2, p7 (9, 12, 15) sts.

**Row 2:** K7 (9, 12, 15) sts, work row 2 Cable 2, work row 2 Cable 3, work row 2 Cable 1, k7 (9, 12, 15) sts.

These 2 rows set pattern. Cont. working in pattern as set until length measures 45(45, 47, 47) cm (incl. band)\*, ending on a RS row. Shape Front Neck

**Next Row:** WS - Dec 1 st at beg next row, then 1 st every alt row 5 times, then 1 st at neck edge every 3rd row 14(14, 16, 16) times (38(42, 46, 52) sts, 53(53, 59, 59) shaping rows). Work 7(7, 1, 1) rows straight. Cast off.

**RIGHT FRONT**

Work as for Left Front to \*, end on a WS row. Cont. as for Left Front to end, rev all shaping.

**BACK**

Using 4.50mm needles, cast on 114(120, 132, 144) sts. Work in K2, p2 rib for 4cm, ending on a WS row and inc 4 sts on last row worked. 114(124, 136, 148) sts). Change to 5.00mm needles.

**Establishment rows:**

**Row 1:** RS  
**Size A** - P7, row 1 Cable 1, row 1 Cable 3, row 1 Cable 2, p4, row 1 Cable 2, p4, row 1 Cable 1, row 1 Cable 3, row 1 Cable 1, p7.  
**Size B** - P9, row 1 Cable 1, row 1 Cable 3, row 1 Cable 2,

p7, row 1 Cable 2, p7, row 1 Cable 1, row 1 Cable 3, row 1 Cable 1, p9.

**Size C** - P12, row 1 Cable 1, row 1 Cable 3, row 1 Cable 2, p6, row 1 Cable 1, p4, row 1 Cable 2, p6, row 1 Cable 2, row 1 Cable 3, row 1 Cable 1, p12.

**Size D** - P15, row 1 Cable 1, row 1 Cable 3, row 1 Cable 2, p9, row 1 Cable 1, p4, row 1 Cable 2, p9, row 1 Cable 2, row 1 Cable 3, row 1 Cable 1, p15.

**Row 2:** WS

**Size A** - K7, row 2 Cable 1, row 2 Cable 3, row 2 Cable 1, k4, row 2 Cable 2, k4, row 2 Cable 2, row 2 Cable 3, row 2 Cable 1, k7.

**Size B** - K9, row 2 Cable 1, row 2 Cable 3, row 2 Cable 1, k7, row 2 Cable 2, k7, row 2 Cable 2, row 2 Cable 3, row 2 Cable 1, k9.

**Size C** - K12, row 2 Cable 1, row 2 Cable 3, row 2 Cable 2, k6, row 2 Cable 2, k4, row 2 Cable 1, k6, row 2 Cable 2, row 2 Cable 3, row 2 Cable 1, k12.

**Size D** - K15, row 2 Cable 1, row 2 Cable 3, row 2 Cable 2, k9, row 2 Cable 2, k4, row 2 Cable 1, k9, row 2 Cable 2, row 2 Cable 3, row 2 Cable 1, k15.

These 2 rows set pattern. Cont working in pattern as set until length measures same as fronts. Cast off.

**SLEEVES**

Using 4.50mm needles, cast on 48(48, 52, 52) sts. Work in k2, p2 rib for 4cm, ending on C row. Change to 5.00mm needles.

**Establishment rows:**

**Row 1:** RS - P2 (2, 4, 4), work

row 1 Cable 1, row 1 Cable 3, row 1 Cable 2, p2 (2, 4, 4).

**Row 2:** K2 (2, 4, 4), work row 2 Cable 2, row 2 Cable 3, row 2 Cable 1, k2 (2, 4, 4).

These 2 rows set pattern. Keeping pattern correct, at the same time shape sides as follows; inc 1 st each end every 3rd row 4(4, 13, 13) times, then 1 st each end every 4th row 20(20, 14, 14) times. 96(96, 106, 106) sts, 92(92, 95, 95) shaping rows). Work straight until Sleeve (incl band) measures 44(44, 46, 46) cm. Cast off.

**MAKING UP**

Press all pieces gently, except ribs, on WS using a warm iron over a damp cloth. Using Backstitch join shoulder seams. Centre sleeves and join, join side & sleeve seams using Edge to Edge st on ribs.

Bands With RS facing, using 4.50mm needles, pick up and knit 94 sts along right front from base to neck shaping. Work in p2, k2 rib for 15 rows.

Cast off in rib. Work left side as for right side, picking up from neck shaping to base.

Collar Using 4.50mm needles, cast on 150 sts. Work in k2, p2 rib for 15 rows. Cast off 3 sts at beg foll 36 rows. Cast off rem 42 sts in rib.

Sew collar into position along cast off edge using Edge to Edge stitch.

Tie Belt Using 4.50mm needles, cast on 10 sts. Work in k1, p1 rib until length measures 170cm. Cast off.

**HAT**

Using 4.50mm needles, cast on 100 sts, work in k2, p2 rib

for 8 rows, inc 29 sts evenly across last WS row.

Change to 5.00mm needles.

**Row 1:** P9, (k6, p15) 5 times, k6, p9.

**Row 2:** K9, (p6, k15) 5 times, p6, k9.

**Row 3:** P9, (C6B, p15) 5 times, C6B, p9.

**Row 4:** as for row 2.

Rep these 4 rows until 13cm (incl. band) have been worked, ending on a WS row.

#### Shape crown

**Row 1:** P2, p2tog, p3, (p2tog, C6B (or k6), p2tog, p4,

p2tog, p5) 5 times, p2tog,

C6B (or k6), p2tog, p3,

p2tog, p2. 110 sts.

**Row 2:** K7, (p6, k12) 5 times, p6, k7.

**Row 3:** P2, p2tog, p1, (p2tog, k6 (or C6B), p2tog, p3,

p2tog, p3) 5 times, p2tog, k6 (or C6B), p2tog, p1, p2tog, p2. 91 sts.

**Row 4:** K5, (p6, k9) 5 times, p6, k5.

**Row 5:** P1, p2tog, (p2tog, C6B (or k6), p2tog, p2,

p2tog, p1) 5 times, p2tog, C6B (or k6), p2tog, p2tog,

p1. 72 sts.

**Row 6:** K3, (p6, k6) 5 times, p6, k3.

**Row 7:** P1, (p2tog, k6 (or C6B), p2tog) 5 times, p2tog,

k6 (or C6B), p2tog, p1. 60 sts.

**Row 8:** K2, (p6, k4) 5 times, p6, k2.

**Row 9:** P2tog, (C6B (or k6), p2tog, p2tog) 5 times, C6B (or k6), p2tog. 48 sts.

**Row 10:** K1, (p6, k2) 5 times, p6, k1.

**Row 11:** P1, (C6B (or k6),

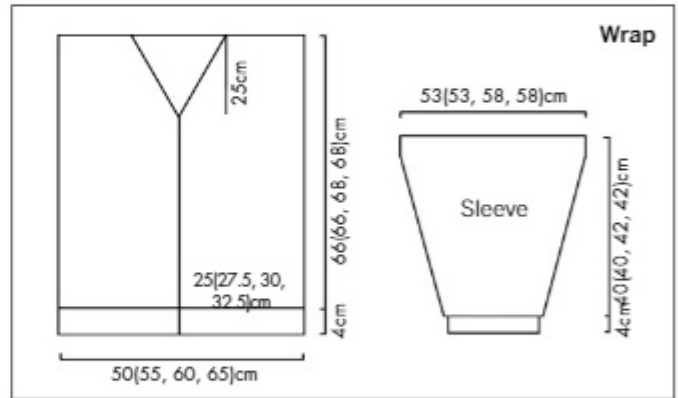
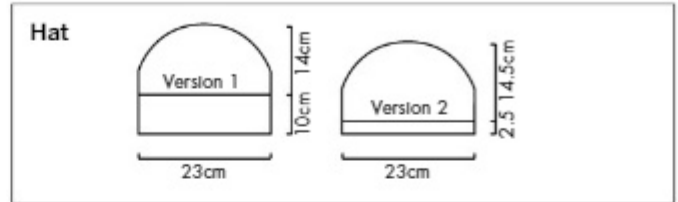

p2tog) 5 times, C6B (or k6), p1. 43 sts.

**Row 12:** P2tog 21 times, p1. 22 sts.

Break yarn, thread through rem 22 sts and draw tog

firmly and secure. Join back seam using Edge to Edge st on ribs.

**Jo Sharp**

[www.josharppatterns.com](http://www.josharppatterns.com)

## Janique of Chelsea

CRAFT SUPPLIES • GIFTS • HOMEWARES • FASHION

#### Specialising in:

- Knitting yarn and needles
- Tapestries and threads
- Haberdashery, beads, trims and accessories

We have the highest quality products and advice for our customers

402 Nepean Hwy  
Chelsea VIC 3196  
Ph: 03 9776 1155  
Fax: 9585 5141

CLECKHEATON • FILATURA • NATURALLY • PANDA • PATONS • WENDY

online store now open  
free australia-wide shipping on all orders over \$100

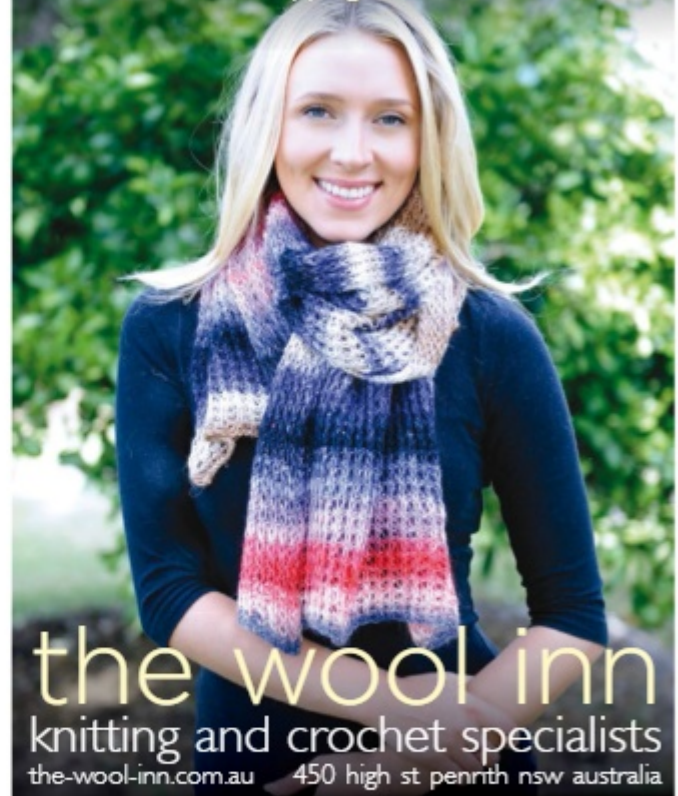

the wool inn  
knitting and crochet specialists  
[the-wool-inn.com.au](http://the-wool-inn.com.au) 450 high st penrith nsw australia

# FAMILY BEANIE

*Design by Patons*



## SKILL LEVEL



## WHAT YOU'LL NEED

### Yarn

1, 1, 1, 1 ball 50gm Patons Patonyle Merino Magic 4ply main colour 5558  
1, 1, 2, 2 balls 50gm Patons Patonyle Merino 4ply contrast colour 1030

### Needles

3.00mm set double-pointed knitting needles  
3.25mm set double-pointed knitting needles  
Wool sewing needle  
Pom-pom maker or piece of cardboard

### Tension

28 sts by 36 rows over stocking st, on 3.25mm needles to 10cm

 **Patons**



## STITCH GUIDE BEANIE

Using set of 3.00mm double-pointed needles and C, cast on 124 (132, 140, 144) sts and divide as evenly as possible between 3 needles. Join to work in rounds, taking care not to twist cast-on edge.

**Round 1:** \* K2, P2, rep from \* to end.

Last round forms rib.

Rep last round until rib measures 7 (8, 10, 10) cm from beg.

Change to set of 3.25mm double-pointed needles and M.

Work in stocking st until beanie measures 13 (14, 17, 19) cm from beg, dec 0 (0, 0, 4) sts evenly in last round. 124 (132, 140, 140) sts.

## Shape Crown

**Next Round:** \* K1, K2tog, K26 (28, 30, 30), sl 1, K1, pss0, rep from \* to end. 116 (124, 132, 132) sts.

Work 1 round.

**Next Round:** \* K1, K2tog, K24 (26, 28, 28), sl 1, K1, pss0, rep from \* to end. 108 (116, 124, 124) sts.

Work 1 round.

**Next Round:** \* K1, K2tog, K22 (24, 26, 26), sl 1, K1, pss0, rep from \* to end. 100 (108, 116, 116) sts.

Cont dec in this manner (working 2 less sts in centre of rep) in every foll alt round

until 44 (44, 28, 28) sts rem, then in every round until 12 sts rem.

Break off yarn, thread end through rem sts, draw up tightly and fasten off securely.

## MAKING UP

Do Not Press. Using C and a large pom-pom maker or two circles of cardboard 12cm in diameter with a 3cm hole, make pom-pom and attach securely to crown.

Patons

Ph: 1800 337 032

[www.patonsyarns.com.au](http://www.patonsyarns.com.au)

### MEASUREMENTS

SIZE	TODDLER	CHILD	WOMAN	MAN
TO FIT HEAD	52	54	56	58CM

**Knitch**  
create • handmade



exquisite yarns

workshops    knitting  
crochet      felting  
spinning    dyeing  
social groups



custom made  
accessories and gifts



mon, tue, wed, fri 9.30am - 4pm | thur 9.30am - 6pm  
sat, sun 8.30am - 4pm

3161 7476 | 85 Latrobe Terrace, Paddington | [www.knitch.com.au](http://www.knitch.com.au)

## NEEDLE NOOK

South Australia's widest range in knitting yarns, patterns and accessories.

Beautiful yarns include wool, cotton, mohair, bamboo and more

Proud stockists of major brands.

**WE'VE MOVED!**  
4/453 Fullarton Rd  
Highgate SA 5063  
Ph: 08 8271 4670

Mail order & phone sales welcome.

[www.needlenook.com.au](http://www.needlenook.com.au)

# STRIPED SCARF IN RIB

*Design by Cleckheaton*

## STITCH GUIDE

Using 7.00mm needles and M, cast on 21 sts.

### Beg Rib Stripe Patt

**Row 1:** K2, \* P1, K1, rep from \* to last st, K1.

**Row 2:** K1, \* P1, K1, rep from \* to end.

Rep last 2 rows twice in M, then 3 times in C.

Last 12 rows form rib stripe patt.

Cont in patt until Scarf measures approx 140cm from beg, ending with a complete stripe.

Cast off loosely in rib.

## MAKING UP

Sew in ends.

Cleckheaton Yarns

1800 337 032

[www.cleckheaton.com.au](http://www.cleckheaton.com.au)

## MEASUREMENTS

WIDTH 10CM

LENGTH 140CM

## SKILL LEVEL



beginner

## WHAT YOU'LL NEED

### Yarn

3 balls 50gm  
Cleckheaton Country  
Wide 14ply main colour  
0024 Airforce  
3 balls 50gm  
Cleckheaton Country  
Wide 14ply contrast  
colour 0022 Brown

### Needles

7.00mm knitting needles  
Wool sewing needle

### Tension

21 sts by 19 rows over  
patt (unstretched), on  
7.00mm needles and M  
to 10cm





# FILATURA DI CROSA®

register  
now at  
[www.naturallyyarnsnz.com](http://www.naturallyyarnsnz.com)  
to get free pattern  
downloads



BKBKE1



BKZAR1



BKSUP1



BKBKE1



BKZAR1



BKSUP1

## Baby Kid Extra™

## Zara™

## Superior™ & Gioiello™



"Like" Us on Facebook

For details of local stockists visit  
[www.naturallyyarnsnz.com](http://www.naturallyyarnsnz.com)

WENTWORTH DISTRIBUTORS NZ LTD. PROUDLY DISTRIBUTES:

(AU): 1800 150 542  
(NZ): 0800 738 998

Naturally

Wendy

Peter Pan

FILATURA  
DI CROSA

2000  
Alpacas

addi



# BABY'S JUMPER AND HAT



## Heart bobble jumper and hat in 8ply prints.

### JUMPER BACK

Using 3.25mm needles and C, cast on 53 (57, 65, 69, 73) sts.

**Row 1:** RS – K1, \* P1, K1, rep from \* to end.

Rep last row for moss st.

Work a further 3 rows moss st.

**Row 5:** K1, \* P1, MB, P1, K1, rep from \* to end (if necessary, push bobbles onto right side of work).

Work a further 3 (3, 5, 5, 5) rows moss st, inc 0 (2, 0, 0, 0) sts evenly across last row.

53 (59, 65, 69, 73) sts.

Change to 4.00mm needles.

### Beg Stripe Patt

**NOTE:** 2 balls of M are used when working stripes. This allows M to be carried up at side edge without breaking off after each stripe.

**Row 1:** RS - Using M Purl.

**Row 2:** Knit.

**Row 3:** Using C, Purl.

**Row 4:** Using another ball of M, Knit.

**Row 5:** Purl.

**Row 6:** Using C, Knit.

Last 6 rows form stripe patt for rem, noting to alternate balls of M (as before).

### Shape Sides

Dec one st at each end of next row, then in every foll

8th (10th, 12th, 14th, 16th) row until 45 (51, 57, 61, 65) sts rem.

Work 5 (7, 9, 11, 9) rows.

### Shape Armholes

Keeping stripe patt correct, cast off 2 sts at beg of next 2 rows. 41 (47, 53, 57, 61) sts. Dec one st at each end of next row, then in every foll alt row 0 (1, 2, 2, 2) times. 39 (43, 47, 51, 55) sts. \*\*

Work 19 (21, 21, 25, 27) rows.

### Shape Back Neck

**Next Row:** P11 (12, 14, 15, 17), turn.

Cont on these 11 (12, 14, 15, 17) sts for right side of back neck.

**Next Row:** K2tog, knit to end.

### Shape Shoulder

**Next Row:** Cast off 5 (5, 6, 6, 7) sts, purl to last 2 sts, P2tog. Work 1 row.

Cast off rem 4 (5, 6, 7, 8) sts. Slip next 17 (19, 19, 21, 21) sts onto stitch-holder and leave for neckband.

With right side facing, join appropriate colour to rem 11 (12, 14, 15, 17) sts for left side of back neck and purl to end.

**Next Row:** Knit to last 2 sts, K2tog.

**Next Row:** P2tog, purl to end

### Shape Shoulder

Cast off 5 (5, 6, 6, 7) sts at beg of next row.

Work 1 row.

Cast off rem 4 (5, 6, 7, 8) sts.

### FRONT

Work as for Back to \*\*.

Work 1 row.

### Divide for Front Opening

**Next Row:** P17 (19, 21, 23, 25), cast off next 5 sts, purl to end. Cont on these 17 (19, 21, 23, 25) sts for right side of front opening.

Work 7 (9, 9, 11, 13) rows.

### Shape Neck

**Next Row:** Cast off 3 (4, 4, 4, 4) sts, purl to end. 14 (15, 17, 19, 21) sts.

Dec one st at neck edge in every foll alt row until 9 (10, 12, 13, 15) sts rem.

Work 2 rows.

### Shape Shoulder

Cast off 5 (5, 6, 6, 7) sts at beg of next row.

Work 1 row.

Cast off rem 4 (5, 6, 7, 8) sts.

With WS facing, join appropriate colour to rem 17 (19, 21, 23, 25) sts for left side of front opening.

Work 8 (10, 10, 12, 14) rows.

### Shape Neck

**Next Row:** WS - Cast off 3 (4, 4, 4, 4) sts, knit to end. 14 (15, 17, 19, 21) sts.

Dec one st at neck edge in next row, then in every foll alt row until 9 (10, 12, 13, 15) sts rem.

Work 1 row.

### SKILL LEVEL



### WHAT YOU'LL NEED

#### Yarn

2, 2, 3, 3, 4 balls 50gm Shepherd Colour 4 Me Prints 8ply main colour – 5009 purple  
2, 2, 2, 3, 3 balls 50gm Shepherd Colour 4 Me 8ply contrast colour – 4984 purple  
2 balls 50gm Shepherd Colour 4 Me 8ply in 4984 purple – Hat

#### Needles

3.25mm knitting needles  
4.00mm knitting needles  
3.25mm set double-pointed knitting needles  
4.00mm set double-pointed knitting needles for Hat.  
Pom-pom maker or piece of cardboard for Hat.  
Wool sewing needle  
Stitch-holder

#### Tension

22 sts by 30 rows over stocking st, on 4.00mm needles to 10cm.

#### Special abbreviation

MB = make bobble – (K1, P1, K1, P1, K1) all into next st, turn, sl 1, P4, turn, sl 1, K4, pass 2nd, 3rd, 4th and 5th sts over first st, completing bobble.

### MEASUREMENTS

SIZE	0	3	6	9	12MTHS
<b>TO FIT CHEST</b>	<b>35</b>	<b>40</b>	<b>45</b>	<b>50</b>	<b>53CM</b>
FINISHED FIT	39	44	49	54	57CM
<b>GARMENT LENGTH</b>	<b>22</b>	<b>26</b>	<b>29</b>	<b>33</b>	<b>35CM</b>
SLEEVE LENGTH	11	13	16	19	21CM
<b>HAT TO FIT</b>		<b>45</b>	<b>50CM</b>		



**Bobble placement to form heart shape**  
(Use 18 bobbles for each Heart Shape)

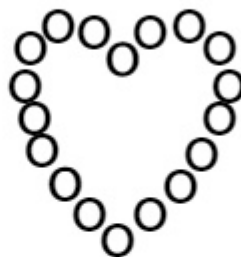

Work 5 rows moss st as for Back.

**Row 6:** K1, \* P1, MB, P1, K1, rep from \* to end.

Work 3 rows moss st.  
Cast off loosely in patt.

**LEFT FRONT BAND**

With RS facing, using 3.25mm needles and C, knit up 13 (13, 13, 17, 17) sts evenly along side edge of neckband and left side of front opening.

Complete as for neckband.

**RIGHT FRONT BAND**

With RS facing, using 3.25mm needles and C, knit up 13 (13, 13, 17, 17) sts evenly along right side of front opening and side edge of neckband.

Complete as for neckband.

**HEART BOBBLES**

**(OPTIONAL, MAKE 36)**

Using 4.00mm needles and C, cast on one st and cont as folls for bobble – (K1, yfwd, K1, yfwd, K1) all into one st, turn, K5, turn, P5, turn, K5, turn, P5, turn, K2tog, K1, K2tog, turn, sl 1, P2tog, pssso.

Fasten off securely, leaving a long end for attaching bobble.

**MAKING UP**

Join side and sleeve seams. Sew in sleeves. Sew end of right front band to 5 sts cast off at centre front. Slip-stitch end of left front band in position underneath. If desired, using 18 bobbles for each heart and following diagram, sew bobbles in position to front as pictured.

**HAT**

**FIRST EAR FLAP**

Using 4.00mm needles, cast on 5 sts.

**Row 1:** RS - P1, (K1, P1) twice.

**Row 2:** Inc in first st, K1, P1,

**Shape Shoulder**

Cast off 5 (5, 6, 6, 7) sts at beg of next row.

Work 1 row.

Cast off rem 4 (5, 6, 7, 8) sts.

**SLEEVES**

Using 3.25mm needles and C, cast on 29 (29, 29, 33, 33) sts.

**Beg Band Patt**

Work 8 (8, 10, 10, 10) rows moss st as for Back, inc 0 (2, 2, 0, 0) sts evenly across last row. 29 (31, 31, 33, 33) sts. Change to 4.00mm needles.

**Beg Stripe Patt**

Work 4 rows stripe patt as for Back.

Keeping stripe patt correct,

inc one st at each end of next row, then in every foll 4th (6th, 6th, 8th, 8th) row until there are 37 (39, 41, 43, 45) sts.

Cont without further shaping until Sleeve measures 11 (13, 16, 19, 21) cm from beg, working last row on wrong side.

**Shape Top**

Keeping stripe patt correct, cast off 2 sts at beg of next 2 rows. 33 (35, 37, 39, 41) sts.

Dec one st at each end of next row, then in every foll alt row until 25 sts rem, then in every row until 15 sts rem.

Cast off rem sts.

**NECKBAND**

Join shoulder seams.

**NOTE – We suggest using a set of double-pointed needles for ease of working the neckband. Work backwards and forwards in rows.**

With RS facing, using set of 3.25mm double-pointed needles and C, knit up 11 (12, 12, 13, 13) sts evenly along right side of front neck to shoulder seam, knit up 3 sts evenly along right side of back neck, knit across sts from back stitch-holder, knit up 3 sts evenly along left side of back neck to shoulder seam, then knit up 11 (12, 12, 13, 13) sts evenly along left side of front neck. 45 (49, 49, 53, 53) sts.

K1, inc in last st. 7 sts.

**Row 3:** Inc in first st, (P1, K1) twice, P1, inc in last st. 9 sts.

**Row 4:** Inc in first st, (K1, P1) 3 times, K1, inc in last st. 11 sts.

**Row 5:** Inc in first st, (P1, K1) 4 times, P1, inc in last st. 13 sts. Keeping moss st patt correct, inc (as before) in first and last st of every row until there are 31 (35) sts.

Work 0 (2) rows moss st patt \*\*  
Break off yarn and leave sts on a spare needle.

**SECOND EAR FLAP**

Work as for First Ear Flap to \*\*. Do not break off yarn.

**Beg Hat**

**Next Row:** Patt across Second Ear Flap sts, turn, cast on 11

(13) sts, turn, with right side facing, patt across First Ear Flap sts, turn, cast on 7 sts, turn. 80 (90) sts.

Rem of Hat is worked in rounds. Slip sts onto set of 4.00mm double-pointed needles so that right side is facing, dividing sts as evenly as possible between 3 needles. Join to work in rounds, taking care not to twist cast on edges.

**Round 1:** \* K1, P1, rep from \* to end.

**Round 2:** \* P1, K1, rep from \* to end.

Last 2 rounds form moss st patt for rem.

Cont in patt until work measures 10 (11) cm from Hat cast on (excluding ear flaps), ending with a 2nd round.

**Shape Crown**

**Round 1:** \* Patt 13 (15), P3tog, rep from \* to end. 70 (80) sts. Work 3 rounds.

**Round 5:** \* Patt 11 (13), P3tog, rep from \* to end. 60 (70) sts. Work 3 rounds.

**Round 9:** \* Patt 9 (11), P3tog, rep from \* to end. 50 (60) sts. Work 3 rounds.

**Round 13:** \* Patt 7 (9), P3tog, rep from \* to end. 40 (50) sts. Work 1 round.

**Round 15:** \* Patt 5 (7), P3tog, rep from \* to end. 30 (40) sts. Work 1 round.

**Round 17:** \* Patt 3 (5), P3tog, rep from \* to end. 20 (30) sts. Work 1 round.

**Size 12 months only**

**Round 19:** \* Patt 3, P3tog, rep

from \* to end. 20 sts.

Work 1 round.

**Both sizes**

**Next round:** \* K1, P3tog, rep from \* to end. 10 sts.

Break off yarn, thread end through rem sts, draw up tightly and fasten off securely.

**MAKING UP**

Do not press.

Using pom-pom maker or two circles of cardboard 9cm in diameter with a 4cm hole in the centre, make a pom-pom. Attach to top of hat, as pictured.

**Shepherd Yarns**

Ph: 1800 337 032

[www.shepherd yarns.com.au](http://www.shepherd yarns.com.au)



**WONDOFLEX**  
YARN CRAFT CENTRE

Visit us at 1353 Malvern Road, Malvern Road  
or shop online safely at: [www.wondoflex.com.au](http://www.wondoflex.com.au)  
**Phone: (03) 9822 6231**

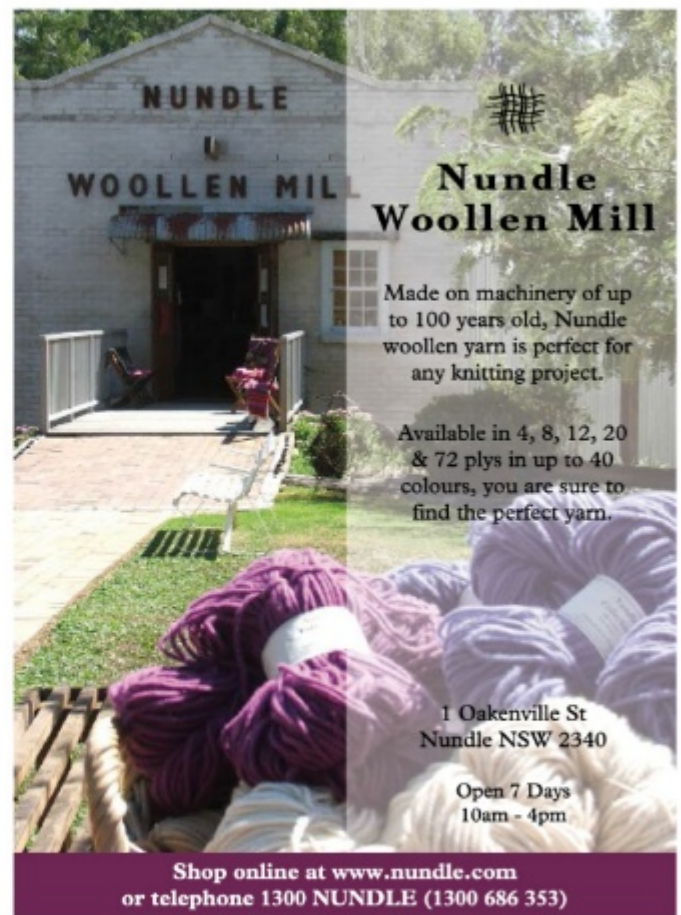

**Nundle**  
Woollen Mill

Made on machinery of up to 100 years old, Nundle woollen yarn is perfect for any knitting project.

Available in 4, 8, 12, 20 & 72 plys in up to 40 colours, you are sure to find the perfect yarn.

1 Oakenville St  
Nundle NSW 2340

Open 7 Days  
10am - 4pm

Shop online at [www.nundle.com](http://www.nundle.com)  
or telephone 1300 NUNDLE (1300 686 353)

# THREE HATS AND ONE SCARF

Design by Gitta Schrade for Naturally Yarns

## SKILL LEVEL



beginner

## WHAT YOU'LL NEED

### Yarn

Loyal Chunky/14ply (50gr)

4, 5 balls 50gm Loyal Chunky14ply Hat 1 & Scarf in shade #955  
2, 2 balls 50gm Loyal Chunky14ply Hat 2 in shade #957

2, 2 balls 50gm Loyal Chunky14ply Hat 3 in shade #956

### Needles

5.50mm knitting needles  
6.00mm knitting needles

### Tension

14 sts by 20 rows over Stocking st on 6.00mm needles to 10cm

### Special abbreviations

skp – slip 1 stitch, knit 1 stitch, pass slipped stitch over;

HAND KNIT YARNS by

*Naturally*  
IT'S PURE  
NEW ZEALAND

www.naturallyyarnsnz.com

## STITCH GUIDE

### HAT & SCARF

#### HAT 1

With 5.50mm needles, cast on 59 (67) sts.

K1, p1 rib for 8 (10) rows and inc 4 (5) sts evenly across last row. 63 (72) sts.

Change to 6.00mm needles.

#### Beg Main Pattern

**Row 1:** RS - K4; \*p1, k8; rep from \* to last 5 sts, p1, k4.

**Row 2:** P3; \*k3, p6; rep from \* to last 6 sts, k3, p3.

**Row 3:** K2; \*p5, k4; rep from \* to last 7 sts, p5, k2.

**Row 4:** P1; \*k7, p2; rep from \* to last 8 sts, k7, p1.

**Row 5:** Purl.

**Row 6:** As row 4.

**Row 7:** As row 3.

**Row 8:** As row 2.

Rep these 8 rows until piece measures 15 (18)cm from beg, end with a row 1 of patt.

**Next Row:** WS - P4, k1; \*p8, k1; rep from \* to last 4 sts, p4.

#### Shape Top

**Next Row:** RS - K2, k2tog; \*p1, skp, k4, k2tog; rep from \* to last 5 sts, p1, skp, k2. 49 (56) sts.

**Next Row:** P3, k1; \*p6, k1; rep from \* to last 3 sts, p3.

**Next Row:** K3; \*p1, k6; rep from \* to last 4 sts, p1, k3.

**Next Row:** P3, k1; \*p6, k1; rep from \* to last 3 sts, p3.

**Next Row:** RS - K1, k2tog; \*p1, skp, k2, k2tog; rep from \* to last 4 sts, p1, skp, k1. 35 (40) sts.

**Next Row:** P2, k1; \*p4, k1; rep from \* to last 2 sts, p2.

**Next Row:** K2; \*p1, k4; rep from \* to last 3 sts, p1, k2.

**Next Row:** P2, k1; \*p4, k1; rep from \* to last 2 sts, p2.

**Next Row:** RS - K2tog; \*p1, skp, k2tog; rep from \* to last 3 sts, p1, skp. 21 (24) sts.

**Next Row:** P1, k1; \*p2, k1; rep from \* to last st, p1.

**Next Row:** RS - K1; \*p1, skp; rep from \* to last 2 sts, p1, k1. 15 (17) sts.

**Next Row:** P1; \*k1, p1; rep from \* to end.

Break yarn, leaving longer end, thread yarn through rem sts, pull together, secure, fasten off.

Join back seam.

### SCARF

With 6.00mm needles, cast on 15 (17) sts.

#### Beg Main Pattern

**Row 1:** RS - K1; \*p1, k1; rep from \* to end.

**Row 2:** P1; \*k1, p1; rep from \* to end.

**Row 3:** P1; \*k1, p1; rep from \* to end.

**Row 4:** K1; \*p1, k1; rep from \* to end.

Rep these 4 rows until piece measures 120 (140)cm from beg (or desired length), end with a row 2 or 4 of patt. Cast off loosely in patt.

### HAT 2

With 5.50mm needles, cast on 61 (70) sts.

**Row 1:** RS - K1; \*p2, k1; rep from \* to end.

**Row 2:** P1; \*k2, p1; rep from \* to end.

Rep last 2 rows 3 (4) times more.

Change to 6.00mm needles.

#### Beg Main Pattern

**Row 1:** RS - K1; \*p2, k1; rep from \* to end.

**Row 2:** Purl.

Rep these last 2 rows for Main patt until piece measures 13 (15)cm from beg, end with a WS row.

## MEASUREMENTS

SIZE	8-10	12-14 YEARS
TO FIT HEAD CIRCUMFERENCE	48	52CM
SCARF WIDTH	10	12.5CM
SCARF LENGTH	120	140CM



### Shape Top

**Next Row:** RS - K1; \*p2, k1, p2tog, k1; rep from \* to last 0 (3) sts, p0 (2), k0 (1). 51 (59) sts.

**Next Row:** Purl.

**Next Row:** RS - K1; \*p2, k1, p1, k1; rep from \* to last 0 (3) sts, p0 (2), k0 (1).

**Next Row:** Purl.

**Next Row:** RS - K1; \*p2tog, k1, p1, k1; rep from \* to last 0 (3) sts, p0 (p2tog), k0 (1). 41 (47) sts.

**Next Row:** Purl.

**Next Row:** K1; \*p1, k1; rep from \* to end.

**Next Row:** Purl.

**Next Row:** K2tog across row, end k1. 22 (24) sts.

**Next Row:** Purl.

**Next Row:** K2tog across row, 11 (12) sts.

**Next Row:** Purl.

Break yarn, leaving longer end, thread yarn through rem sts, pull together, secure, fasten off.

Join back seam.

### HAT 3

With 5.50mm needles, cast on 61 (70) sts.

**Row 1:** RS - K1; \*p2, k1; rep from \* to end.

**Row 2:** P1; \*k2, p1; rep from \* to end.

Rep last 2 rows 3 (4) times more.

Change to 6mm needles.

### Beg Main Pattern

**Row 1:** RS - Knit.

**Row 2:** Purl.

**Row 3:** K1; \*p2, k1; rep from \* to end.

**Row 4:** Purl.

Rep these last 4 rows for Main patt until piece measures 13 (15)cm from beg, end with a WS row.

### Shape Top

**Next Row:** RS - K1 (0); \*k2, k2tog, k1; rep from \* to end. 49 (56) sts.

**Next Row:** Purl.

**Next Row:** RS - Purl.

**Next Row:** Purl.

**Next Row:** RS - K1 (0); \*k1, k2tog, k1; rep from \* to end.

37 (42) sts.

**Next Row:** Purl.

**Next Row:** RS - K1 (0); \*k2tog, k1; rep from \* to end. 25 (28) sts.

**Next Row:** WS - Knit.

**Next Row:** RS - K1 (0); \*k2tog; rep from \* to end. 13 (14) sts.

**Next Row:** Purl.

Break yarn, leaving longer

end, thread yarn through rem sts, pull together, secure, fasten off.

Join back seam.

**Wentworth Distributors NZ Ltd**

Free phone AU: 1800 150 542

Free phone NZ: 0800 738 998

[www.naturallyyarnsnz.com](http://www.naturallyyarnsnz.com)

Hat 1 and Scarf



Hat 3



Hat 2



# EASY RAGLAN PULLOVER

Design by Sandi Prosser for Filatura Di Crosa

## STITCH GUIDE

### BACK

With 3.75mm needles, cast on 62 (70, 78, 82) sts.

**Row 1:** RS - K2, \*p2, k2; rep from \* to end.

**Row 2:** P2, \*k2, p2; rep from \* to end.

Work a further 6 rows in k2, p2 rib and dec 4 (5, 8, 7) sts evenly across last row. 58 (65, 70, 75) sts.

Change to 4.00mm needles. Starting with a knit (RS) row, work in Stst until piece measures 15 (16.5, 20.5, 23) cm from beg, end with a WS row.

### Shape Raglan

Cast off 3 (3, 4, 4) sts at beg of next 2 rows.

**Next Row:** RS - K1, k2tog, k to last 3 sts, skp, k1.

Work 3 rows even.

Rep last 4 rows 1 (0, 0, 0) times more.

**Next Row:** RS - K1, k2tog, k to last 3 sts, skp, k1.

Work 1 row even.

Rep last 2 rows to 24 (25, 26, 27) sts. Leave on holder.

### FRONT

Work as given for Back to 36 (37, 38, 39) sts, end with a WS row.

### Shape Neck

**Next Row:** RS - K1, k2tog, k 9, turn, on these 11 sts only.

Work 1 row.

Dec 1 st at neck edge next 4 rows and at armhole edge every RS row 4 times. 3 sts.

**Next Row:** RS - K1, k2tog, 2 sts.

**Next Row:** WS - P2.

**Next Row:** RS - K2tog. Fasten off.

With RS facing, return to sts on hold, rejoin yarn, k next 12 (13, 14, 15) sts and slip these to holder for centre front neck, work 2nd half to match, reversing shaping.

### SLEEVES

With 3.75mm needles, cast on 34 (38, 38, 42) sts.

**Row 1:** RS - K2, \*p2, k2; rep from \* to end.

**Row 2:** P2, \*k2, p2; rep from \* to end.

Work a further 6 rows in k2, p2 rib, inc 2 (0, 2, 2) sts evenly across last row. 36 (38, 40, 44) sts.

Change to 4.00mm needles. Starting with a knit (RS) row, work in Stst, inc 1 st each end of 7th and every following 8th (8th, 6th, 8th) row to 46 (50, 56, 60) sts.

Work even until sleeve measures 20.5 (21.5, 24, 28) cm from beg, end with a WS row.

### Shape Raglan

Cast off 3 (3, 4, 4) sts at beg of next 2 rows.

**Next Row:** RS - K1, k2tog, k to last 3 sts, skp, k1.

Work 3 (3, 3, 3) rows even.

Rep last 4 rows 0 (1, 0, 0) times more.

**Next Row:** RS - K1, k2tog, k to last 3 sts, skp, k1.

Work 1 row even.

Rep last 2 rows to 10 (10, 12, 12) sts. Leave on holder.

### MAKING UP

Block pieces to measurements. Join raglan seams, leaving right back raglan open.

### NECKBAND

With RS facing and 3.75mm needles, k the 24 (25, 26, 27) back neck holder sts, k the 10 (10, 12, 12) left sleeve holder

sts, pick up and k7 (8, 7, 8) sts down left front neck, k the 12 (13, 14, 15) front neck holder sts, pick up and k7 (8, 7, 8) sts up right front neck, k the 10 (10, 12, 12) right sleeve holder sts. 70 (74, 78, 82) sts.

Knit 3 rows, end with a WS row.

## SKILL LEVEL



beginner

## WHAT YOU'LL NEED

### Yarn

3, 4, 5, 5 balls 50gm Zara extra fine Merino Wool in shade #4000  
2 buttons

### Needles

3.75mm knitting needles  
4.00mm knitting needles  
3.75mm crochet hook (for button loop and edge)  
Stitch holders

### Tension

22 sts and 30 rows over Stst - 10cm on 4mm needles.

### Special abbreviations

skp - slip 1 stitch, k 1 stitch, pass slipped st over

## MEASUREMENTS

SIZE	12	18MTHS	2	4 YEARS
<b>FINISHED FIT</b>	<b>53</b>	<b>59</b>	<b>64</b>	<b>68CM</b>
GARMENT LENGTH	26.5	29.5	34.5	38CM
<b>SLEEVE LENGTH</b>	<b>20.5</b>	<b>21.5</b>	<b>24</b>	<b>28CM</b>



**Row 1:** RS - K2, \*p2, k2; rep from \* to end.

**Row 2:** P2, \*k2, p2; rep from \* to end.

Work a further 2 rows in k2, p2 rib.

Cast off all sts in rib.

Join right back raglan, leaving an opening 7.5cm long from top of neckband.

With RS facing and 3.75mm crochet hook, work 1 row double crochet evenly along raglan opening, working chain 4 buttonloop on back 5cm/2ins from top and again 1cm from top. Fasten off.

Sew buttons opposite buttonloops on left sleeve. Join side and sleeve seams.

**Wentworth Distributors NZ Ltd**  
Free phone AU: 1800 150 542  
Free phone NZ: 0800 738 998  
[www.naturallyyarnsnz.com](http://www.naturallyyarnsnz.com)

# GARTER STITCH JACKET WITH HOOD

*Design by Charmaine Connell for Naturally Yarns*

## STITCH GUIDE

### BACK

With 4.00mm needles, cast on 42 (48, 54, 60, 66) sts.

Garter Stitch (k every row) for 24 (26, 28, 30, 32)cm, end with a WS row.

Cast off loosely.

### LEFT FRONT

With 4.00mm needles, cast on 24 (27, 29, 32, 35) sts.

Garter Stitch until front measures 5cm less than back, end with a RS row.

### Shape Neck

Cast off 6 (6, 6, 7, 7) sts beg of next WS row.

Dec 1 st at neck edge next row, then every other row until 15 (17, 19, 21, 23) sts rem.

Garter Stitch straight until front measures same as back to shoulder, end with a WS row.

Cast off loosely.

### RIGHT FRONT

With 4.00mm needles, cast on 24 (27, 29, 32, 35) sts.

Garter Stitch until front measures 5cm less than back, end with a WS row.

### Shape Neck

Cast off 6 (6, 6, 7, 7) sts beg of next RS row.

Dec 1 st at neck edge next row, then every other row until 15 (17, 19, 21, 23) sts rem.

Garter Stitch straight until front measures same as back to shoulder, end with a RS row.

Cast off loosely.

## SKILL LEVEL



beginner

## WHAT YOU'LL NEED

### Yarn

2, 3, 4, 4, 5 balls 50gm Classic Prints DK 8ply in shade #877

2, 2, 3, 3, 3 buttons - Incomparable Buttons: L572

### Needles

4.00mm knitting needles

### Tension

21 sts over Garter Stitch on 4.00mm needles to 10cm



HAND KNIT YARNS by

*Naturally*  
IT'S PURE  
NEW ZEALAND

[www.naturallyyarnsnz.com](http://www.naturallyyarnsnz.com)

## SLEEVES

With 4.00mm needles, cast on 27 (29, 31, 33, 35) sts.

Garter Stitch 11 rows.

Cont in Garter Stitch and inc 1 st each end next row then every 10th (10th, 9th, 8th, 8th) row until there are 35 (39, 43, 47, 51) sts on needle.

Garter Stitch straight until Sleeve measures 14 (15, 17, 18, 19)cm from beg, end with a WS row.

Cast off loosely.

## HOOD

With 4.00mm needles, cast on 78 (86, 94, 102, 110) sts.

Garter Stitch 7 rows.

**Next Row:** K2tog, k to last 2 sts, k2tog.

**Next Row:** Knit.

Rep last two rows until 58 (66, 72, 80, 86) sts rem.

Garter Stitch straight until work measures 11 (13, 14, 15, 16)cm from cast on edge.

## Decrease For Back Neck

Cast off 3 sts beg of next 10 (10, 12, 12, 14) rows - 28 (36, 36, 44, 44) sts.

Cast off loosely.

Sew back seam of hood.

## TAB (MAKE 2 (2, 3, 3, 3))

With 4.00mm needles, cast on 5 sts.

Garter Stitch for 3cm.

**Next Row:** Make buttonhole: K2, yo, k2tog, k1.

Garter Stitch further 3 rows.

## MEASUREMENTS

SIZE	0-3	3-6	6-9	9-12	1-2 YEARS
<b>FINISHED FIT</b>	<b>40</b>	<b>45</b>	<b>51</b>	<b>57</b>	<b>62CM</b>
GARMENT LENGTH	24	26	28	30	32CM
<b>SLEEVE LENGTH</b>	<b>14</b>	<b>15</b>	<b>17</b>	<b>18</b>	<b>19CM</b>

**Next Row:** K2tog, k1, k2tog - 3 sts.

Cast off.

## MAKING UP

Join shoulders.

Sew hood in place, easing in to fit and ensure to fold front edge of hood back to create brim.

Fold sleeve in half and mark centre at top of sleeve. Pin sleeve tops to each side of back

and fronts, matching centre sleeve to shoulder point.

Join side and sleeve seams.

Sew the tabs to right or left front.

Sew buttons on opposite front to match (see photo as placement guide).

**Wentworth Distributors NZ Ltd**

Free phone AU: 1800 150 542

Free phone NZ: 0800 738 998

[www.naturallyyarnsnz.com](http://www.naturallyyarnsnz.com)



**KNITTING YARNS BY MAIL**  
[www.knittingyarns.com.au](http://www.knittingyarns.com.au)

Your one stop shop for the very best yarns, knitting patterns, needles and accessories.

**FREE catalogue now available**

Knitting yarns by mail  
114 Fox & Fanckes Rd, Boolarra Sth, Vic 3870  
Email: [stokesay@bigpond.com](mailto:stokesay@bigpond.com)  
Ph: 0408 992 927



**100% AUSTRALIAN ALPACA**  
*sourced from some of Australia's leading alpaca studs*

50g balls  
100% Australian Alpaca - 2, 4, & 8 ply  
83% Australian Alpaca in Boucle - 10 ply  
70% Australian Alpaca / 30% Silk - 1 ply  
Shade card available

**alpaca ultimate**

Shop online at  
[www.alpacaultimate.com.au](http://www.alpacaultimate.com.au)

A Member of  Australian Alpaca ASSOCIATION

Owned by Lualto Alpacas, Yass, NSW • 02 6227 3158 • 0429 783 575



# ANNE MARIE

*A 3-colour stripe cardigan using DK wool.*

## STITCH GUIDE

Before starting to knit, read through the whole pattern, and check your tension. A good way to keep track of the size you are going to knit is to circle it throughout the pattern before starting.

## STRIPES FOR BODICE

Cc1 \*\*3 rows  
 Mc – 3 rows  
 Cc2 – 21 rows  
 Mc – 3 rows  
 Cc1 – 3 rows  
 Mc – 21 rows  
 Cc2 – 3 rows



Mc – 3 rows  
 Cc1 – 21 rows  
 Mc – 3 rows  
 Cc2 – 3 rows  
 Mc – 21 rows  
 Repeat from \*\*

## STRIPES FOR SLEEVE

Mc – \*\*3 rows  
 Cc2 – 3 rows  
 Mc – 19 rows  
 Cc1 – 3 rows  
 Mc – 3 rows  
 Cc2 – 19 rows  
 Mc – 3 rows  
 Cc1 – 3 rows  
 Mc, 19 rows  
 Cc2 – 3 rows  
 Mc – 3 rows  
 Cc1 – 19 rows  
 Repeat from \*\*

## WORKING PATTERN FRONT AND BACK

Knitted in one piece, back and forth on circ needle so opening of cardigan automatically will be in front. Using Mc cast on 176 (188, 200, 212, 224, 236) sts with size 4.00mm circ needle (80 cm). Work single rib 10 cm.

Change to stocking st and work 2 rows Mc, then work stripes.

## ROUND NECK

When garment measures 38 (38, 39, 39, 40, 40) cm, divide into three sections for Left FRONT, Right FRONT and BACK to be worked separately. Dec for armholes as foll, starting from RS: K 39 (42, 44, 47, 49, 52) cast off 10 (10, 12, 12, 14, 14) K 78(84, 88, 94, 98, 104) cast off 10 (10, 12, 12, 14, 14) K 39, 42, 44, 47, 49, 52.

## LEFT FRONT

On size 4mm knitting needles P 39 (42, 44, 47, 49, 52) sts up to first cast off for armhole. Leave remaining sts on circ needle. Cont to work stocking st and stripes. When armhole measures 11(11, 12, 12, 13, 13) cm, dec for neck as foll: On WS cast off first 10 (10, 11, 11, 12, 12) sts. Then dec1, one st in from neckline, every other row 3 times.

## SKILL LEVEL



## WHAT YOU'LL NEED

### Yarn

7, 7, 8, 8, 8, 8 balls 50gm Biggan Merino first cross DK wool main colour – shade 125  
 3 balls 50gm Biggan Merino first cross DK wool colour 1 – shade 000  
 3, 3, 4, 4, 4, 4, 50gm Biggan Merino first cross DK wool colour 2 – shade 185  
 8 Buttons

### Needles

3.00mm double-ended needles  
 3.00mm circular needles 60 cm  
 4.00mm knitting needles  
 4.00mm circular needles 40cm  
 4.00mm circular needles 80cm

### Tension

22 sts by 29 rows stocking stitch on 4.00mm needles to 10cm

## MEASUREMENTS

TO FIT BUST	80	85	90	95	100	105CM
<b>GARMENT LENGTH</b>	<b>60</b>	<b>60</b>	<b>62</b>	<b>62</b>	<b>64</b>	<b>64CM</b>
SLEEVE LENGTH:	46	46	48	48	50	50CM



When armhole measures 22 (22, 23, 23, 24, 24) cm cast off.

### RIGHT FRONT

On 4.00mm knitting needles K 39 (42, 44, 47, 49, 52) sts from Right Front edge up to cast off for other armhole. Work as Left FRONT, reverse shaping.

### BACK

Work the remaining 78 (84, 88, 94, 98, 104) sts onto

4.00mm knitting needles. When armhole measures 21 (21, 22, 22, 23, 23) cm cast off.

### MAKING UP

#### Shoulder Seams

Steam (DON'T PRESS) lightly with iron around armhole and neck to flatten the edges. Pin edges of armhole and neck alternately onto ironing board before steaming, if you find this easier. Using yarn in same colour as last stripe,

sew shoulder seams together from RS, in back loops of cast off sts with an overcast stitch (similar to hemming stitch). This makes a decorative and smooth seam.

### SLEEVES

Work full sleeves from armhole down so there are no seams to sew together at the end

With Mc pick up 104 (104, 110, 110, 116, 116) sts around armhole on size 4mm circ needle (40 cm).

Work stocking st (= only K sts on circ needle when knitting in the round) and stripes for sleeve. After 2 rows dec1 in beg and end of row as foll, starting from beg of row: K2, K2 tog, K 90 (90, 96, 96, 102, 102) K2 tog, K2. Rep this dec every 4th row 8 (8, 9, 9, 10, 10) more times and then every 6th row 8 times (70, 70, 74, 74, 78, 78 left).

Make sure that you keep 4 sts between dec at underarm of sleeve, and that dec are kept straight under each other all the way down.

When sleeve measures 39 (39, 40, 40, 42, 42) cm, or desired length, dec 12 sts evenly distributed over row, so 58 (58, 62, 62, 66, 66) sts remain.

Change to four 3.00mm double-ended needles and work 7 (7, 8, 8, 8, 8) cm in a firm single rib. Cast off quite loosely, so edge stays elastic.

### ROUND NECK AND FRONT EDGES

#### Left Front Edge

With Mc and size 4mm circ needle (80 cm) pick up 112 (112, 118, 118, 122, 122) sts. Work 9 rows firm single rib. Cast off quite firmly.

#### Right Front Edge

Work as Left Front edge, but on rows 4 and 5 make 7 buttonholes, evenly spaced (remember that an 8th buttonhole will be added on to Right side of neckband). Make first buttonhole 5 sts from bottom edge and last one placed so it will be evenly spaced from 8th buttonhole on neckline edge band, with the other 6 buttonholes distributed evenly in between.

### ROUND NECK

With Mc and 3.00mm circ needle (60 cm) pick up around neck as foll: 10 (10, 11, 11, 12, 12) sts along Right Front edge, 30 (30, 32, 32, 34, 34) sts along Right neckline, 26 (26, 30, 30, 34, 34) sts along Back, 30 (30, 32, 32, 34, 34) sts along Left neckline, 10 (10, 11, 11, 12, 12) sts along Left Front edge 106 (106, 114, 114, 126, 126) in all. Work 9 rows in a firm single rib. On 4th and 5th row make one buttonhole over 3 sts, 4 sts from Right Front edge. Cast off quite firmly.

### BUTTONHOLE

Each buttonhole is worked over 3 sts, which are cast off on row 4 and then cast on again on row 5, straight over the sts that were cast off on the previous row for buttonhole.

### MAKING UP

Fasten off all loose ends. On Left Front edge sew on 8 buttons.

**Biggan Design Pty Ltd**  
**PO Box 798**  
**Kenmore QLD**  
**Ph: 07 3378 4453**  
**www.biggandesign.com.au**



# TIMELESS ESSENTIALS

*If you're looking for classic knitwear designs, our Classic Knits Books will surely appeal to you! With over 80 options in 5, 8 and 12 ply to create and treasure forever!*

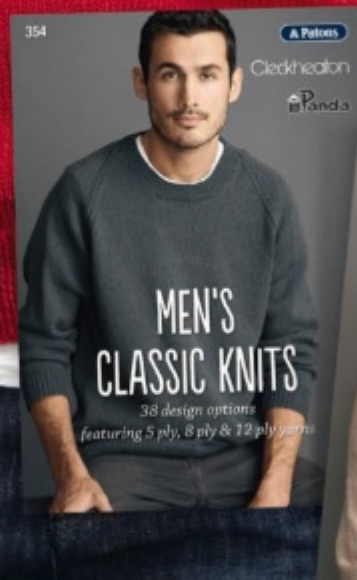

Men's Classic Knits Book 354



Women's Classic Knits Book 301

Phone 1800 337 032 for your nearest stockist.

 /auspinners

  
patonsyarns.com.au

Cleckheaton  
cleckheaton.com.au

  
pandayarns.com.au

# HAT AND FINGERLESS GLOVES

*Design by Gitta Schrade for Naturally Yarns*



## SKILL LEVEL



## WHAT YOU'LL NEED

### Yarn

1 ball 50gm Waikiwi Prints 4ply in shade #473 - hat  
1, 2 balls 50gm Waikiwi 4ply in shade #424 - gloves

### Needles and tools

3.00mm knitting needles  
3.25mm knitting needles

### Tension

28 sts by 36 rows over Stocking Stitch on 3.25mm needles to 10cm

### Special abbreviations

M1 - k into back of strand between stitch just worked and next stitch.

HAND KNIT YARNS by  
*Naturally*  
IT'S PURE  
NEW ZEALAND

[www.naturallyyarnsnz.com](http://www.naturallyyarnsnz.com)

## MEASUREMENTS

HAT TO FIT MEDIUM SIZE ADULT HEAD

GLOVES TO FIT SMALL (MEDIUM) ADULT HAND

LENGTH APPROX 25.5CM

## WORKING PATTERN HAT

With 3.00mm needles, cast on 140 sts.

**Row 1:** RS - \*K1, p4, k4, p4, k1; rep from \* to end.

**Row 2:** \*P1, k12, p1; rep from \* to end.

Rep last 2 rows 3 times more. Change to 3.25mm needle.

**Row 9:** RS - \*K1, p5, k1; rep from \* to end.

**Row 10:** \*P1, k5, p1; rep from \* to end.

Rep last 2 rows twice more.

**Row 15:** \*K2, p4, k2, p4, k2; rep from \* to end.

**Row 16:** \*K6, p2, k6; rep from \* to end.

Rep last 2 rows 3 times more. **Rows 23 – 28:** Rep Rows 9 – 14 once.

**Row 29:** As row 1.

**Row 30:** As row 2.

Rep last 2 rows 3 times more.

**Next Row:** RS - \*K1, p5, k1; rep from \* to end.

**Next Row:** \*P1, k5, p1; rep from \* to end.

Rep last 2 rows until piece measures 17cm from beg, end with a WS row.

### Shape Top

**Next Row:** RS - \*K1, p2, p2tog, p1, k2, p5, k1; rep from \* to end. 130 sts.

**Next Row:** \*P1, k5, p2, k4, p1; rep from \* to end.

**Next Row:** RS - \*K1, p4, k2, p1, p2tog, p2, k1; rep from \* to end. 120 sts.

**Next Row:** \*P1, k4, p1; rep from \* to end.

**Next Row:** RS - \*K1, p1, p2tog, p1, k2, p4, k1; rep from \* to end. 110 sts.

**Next Row:** \*P1, k4, p2, k3, p1; rep from \* to end.

**Next Row:** RS - \*K1, p3, k2,

p1, p2tog, p1, k1; rep from \* to end. 100 sts.

**Next Row:** \*P1, k3, p1; rep from \* to end.

**Next Row:** RS - \*K1, p1, p2tog, k2, p3, k1; rep from \* to end. 90 sts.

**Next Row:** \*P1, k3, p2, k2, p1; rep from \* to end.

**Next Row:** RS - \*K1, p2, k2, p2tog, p1, k1; rep from \* to end. 80 sts.

**Next Row:** \*P1, k2, p1; rep from \* to end.

**Next Row:** RS - \*K1, p2tog, k2, p2, k1; rep from \* to end. 70 sts.

**Next Row:** \*P1, k2, p2, k1, p1; rep from \* to end.

**Next Row:** RS - \*K1, p1, k2, p2tog, k1; rep from \* to end. 60 sts.

**Next Row:** \*P1, k1, p1; rep from \* to end.

**Next Row:** RS - K1, p1; \*k2tog, p1; rep from \* to last st, k1. 41 sts.

**Next Row:** P1; \*k1, p1; rep from \* to end.

**Next Row:** RS - K2tog across row, end k1. 21 sts.

**Next Row:** P2tog across row, end p1. 11 sts.

Break yarn, leaving longer end, thread end through rem sts, draw up very carefully (ensure not to break yarn) and rep threading through once or twice more, then secure end. Join back seam.

## FINGERLESS GLOVES (MAKE 2)

Using 3.00mm needles, cast on 56 (70) sts.

**Row 1:** RS - \*K1, p4, k4, p4, k1; rep from \* to end.

**Row 2:** \*P1, k12, p1; rep from \* to end.

Rep last 2 rows 3 times more. Change to 3.25mm needle.

**Row 9:** RS - \*K1, p5, k1; rep from \* to end.

**Row 10:** \*P1, k5, p1; rep from \* to end.

Rep last 2 rows twice more.

**Row 15:** \*K2, p4, k2, p4, k2; rep from \* to end.

**Row 16:** \*K6, p2, k6; rep from \* to end.

Rep last 2 rows 3 times more.

**Row 23:** \*K1, p2, p2tog, p1, k2, p5, k1; rep from \* to end. 52 (65) sts.

**Row 24:** \*P1, k5, p2, k4, p1; rep from \* to end.

**Row 25:** \*K1, p4, k2, p1, p2tog, p2, k1; rep from \* to end. 48 (60) sts.

**Row 26:** \*P1, k4, p1; rep from \* to end.

**Row 27:** \*K1, p4, k1; rep from \* to end.

**Row 28:** \*P1, k4, p1; rep from \* to end.

**Row 29:** \*K1, p3, k4, p3, k1; rep from \* to end.

**Row 30:** \*P1, k10, p1; rep from \* to end.

Rep last 2 rows 3 times more.

**Row 37:** \*K1, p4, k1; rep from \* to end.

**Row 38:** \*P1, k4, p1; rep from \* to end.

Rep last 2 rows twice more.

**Next Row:** RS - K1, M1, k22 (28), M1, k2, M1, k22 (28), M1, k1. 52 (64) sts.

**Next Row:** WS – Knit all sts. Stst straight until piece measures 22cm from beg,

end with a RS row.

**Next Row:** WS - P4 (1); (p2tog, p10 (7)) 4 (7) times. 48 (57) sts.

Change to 3.00mm needles. K1, p1 rib for 10 rows.

Cast off loosely in rib. Beg at cast-off edge, join

seam for approx 6cm. Place marker 4 (4.5)cm down each side.

## THUMB

With RS facing and 3.25mm needles, beg at marker, pick up and k10 (12) sts from marker to seam and again 10 (12) sts from seam to 2nd marker – 20 (24) sts.

Row (WS) – P.

**Next Row:** RS - K4, turn, slip first st firmly, p to end.

**Next Row:** K20 (24).

**Next Row:** WS - P4, turn, slip first st firmly, k to end.

**Next Row:** P20 (24).

**Next Row:** RS - K6, turn, slip first st firmly, p to end.

**Next Row:** K20 (24).

**Next Row:** P6, turn, slip first st firmly, k to end.

**Next Row:** P20 (24).

**Next Row:** RS - K7 (8), turn, slip first st firmly, p to end.

**Next Row:** K20 (24).

**Next Row:** P7 (8), turn, slip first st firmly, k to end.

**Next Row:** P20 (24).

**Next Row:** RS - K8 (10), turn, slip first st firmly, p to end.

**Next Row:** K20 (24).

**Next Row:** P8 (10), turn, slip first st firmly, k to end.

**Next Row:** P4 (5), p2tog, p8 (10), p2tog, p4 (5). 18 (22) sts.

Change to 3.00mm.

K1, p1 rib for 4 rows.

Cast off loosely in rib.

## MAKING UP

Join thumb and rem side seam.

**Wentworth Distributors NZ Ltd**

Free phone AU: 1800 150 542

Free phone NZ: 0800 738 998

[www.naturallyyarnsnz.com](http://www.naturallyyarnsnz.com)



## STITCH GUIDE

Note – This sweater dress has been worked on larger needles and at a looser tension than normally recommended.

## BACK AND FRONT ALIKE (MAKE 2)

Using 9.00mm needles, cast on 54 (58, 62, 70, 74) sts.

### Beg Lower Band

**Row 1:** K2, \* P2, K2, rep from \* to end.

**Row 2:** P2, \* K2, P2, rep from \* to end.

Rep last 2 rows once, dec 2 (0, 0, 2, 0) sts evenly across last row. 52 (58, 62, 68, 74) sts, 4 rows rib in all.

Work in stocking st until work measures 65cm from beg, ending with a purl row.

## SKILL LEVEL



## WHAT YOU'LL NEED

### Yarn

14, 16, 17, 19, 20 balls  
50gm Patons Inca in  
colour 7043

### Needles

9.00mm knitting needles  
6.00mm knitting needles  
Wool sewing needle

### Tension

11 sts by 16 rows over  
stocking st, on 9mm  
needles to 10cm

### Special abbreviation

M1 = make one – pick up loop which lies before next st, place on left-hand needle and knit into back of loop.

# SWEATER DRESS

Design by Patons in Inca

## Shape Armholes

Cast off 8 (10, 11, 13, 14) sts loosely at beg of next 2 rows. 36 (38, 40, 42, 46) sts. Cont in stocking st until armholes measure 21 (22, 23, 24, 25) cm from cast off, ending with a purl row. Cast off loosely.

## SLEEVES

Using 6.00mm needles, cast on 26 (26, 26, 26, 30) sts.

## Beg Cuff

Work 13 rows rib as for lower band of Back and Front.

**Row 14:** Inc purlways in each of next 2 sts, \* K2, inc

purlways in each of next 2 sts, rep from \* to end. 40 (40, 40, 40, 46) sts.

Change to 9.00mm needles. Work 4 rows stocking st.

**Row 5:** K2, M1, knit to last 2 sts, M1, K2. 42 (42, 42, 42, 48) sts.

Cont in stocking st, inc one st (as before) at each end of every foll 22nd (14th, 10th, 8th, 14th) row until there are 46 (48, 50, 52, 54) sts.

Cont without shaping until Sleeve measures 54cm from beg, ending with a purl row.

Tie a coloured thread at each end of last row to mark end of sleeve seam.

Work a further 12 (14, 16, 18, 20) rows.

Cast off loosely.

## MAKING UP

Do not press. Join shoulder seams, leaving 24 (25, 25, 26, 26) cm at centre of back and front unsewn for neck opening. Join side and sleeve

seams to coloured threads. Sew in sleeves, placing centre of sleeve to shoulder seam and rows above coloured threads to sts cast off at armholes on back and front.

**Patons**

**Ph: 1800 337 032**

**[www.patonsyarns.com.au](http://www.patonsyarns.com.au)**

## MEASUREMENTS

SIZE	XS	S	M	L	XL
<b>TO FIT BUST</b>	<b>70</b>	<b>80</b>	<b>90</b>	<b>100</b>	<b>110CM</b>
<b>FINISHED FIT</b>	90	100	110	120	130CM
<b>GARMENT LENGTH</b>	<b>86</b>	<b>87</b>	<b>88</b>	<b>89</b>	<b>90CM</b>
<b>SLEEVE LENGTH</b>	54CM				



## See your colours in perfect natural light, day and night



The 18w low heat daylight tube in the professional artist lamp gives you more natural daylight than ever before making perfect colour matching so much easier. The Daylight tube shows you true colours and reduces the eye strain caused by glare.

The professional artist lamp comes with a fully flexible arm and two unique clamps, one for easels and one for tables. So pick up your brushes now and start working on your next masterpiece.

## Mix and match perfect colours anytime of the day!



art tracing light box  
A32000



compact lamp  
A33050



ultraslim fluorescent  
A22020

For more information: 07 3283 3092 or [www.daylightcompany.com](http://www.daylightcompany.com)

# FITTING SHORT VEST

Design by Gitta Schrade for Naturally Yarns

## SKILL LEVEL



intermediate

## WHAT YOU'LL NEED

### Yarn

3, 4, 4, 4, 5, 5 Hanks  
50gm Harmony Colour  
Tweed DK/8ply in shade  
#38  
3 Incomparable Buttons:  
L594

### Needles and tools

3.75mm knitting needles  
4.00mm knitting needles  
Stitch holders and  
markers

### Tension

22 sts and 30 rows over  
Stst - 10cm on 4mm  
needles

## WORKING PATTERN BACK

With 4.00mm needles, cast on  
95 (101, 107, 113, 119, 125) sts.

**Row 1:** RS - K4; \*p3, k3; rep  
from \* to last st, k1.

**Row 2:** P1; \*p3, k3; rep from \*  
to last 4 sts, p4.

Rep these 2 rows until piece  
measures 23cm from beg,  
end with a WS row.  
Stst for 6 rows.

### Shape Armholes

Cont in Stst and cast off 6 (7,  
7, 8, 9, 9) sts beg next 2 rows.  
Dec 1 st each end next 4 rows.  
Dec 1 st each end every RS  
row 4 (5, 6, 6, 6, 7) times. 67  
(69, 73, 77, 81, 85) sts.  
Stst straight until work  
measures 42 (42, 43, 43, 44,  
44)cm from beg, end with a  
WS row.

### Shape Neck

**Next Row:** RS - K23 (24, 25,  
27, 28, 29) sts, Turn, on these  
sts only.  
Cast off 2 sts beg next 3 WS  
rows.

Cast off loosely the rem 17  
(18, 19, 21, 22, 23) sts for  
shoulder.

**Next Row:** RS - Return to rem  
sts, slip next 21 (21, 23, 23, 25,  
27) sts to holder for centre  
back neck, rejoin yarn, k to  
end.

Cast off 2 sts beg next 3 RS  
rows.

Cast off loosely the rem 17  
(18, 19, 21, 22, 23) sts for  
shoulder.

## LEFT FRONT

With 4.00mm needles, cast on  
52 (55, 58, 61, 64, 67) sts.

**Row 1:** RS - Knit.

**Row 2:** WS - Knit.

Rep last 2 rows twice more.

**Row 7:** RS - Knit.

**Row 8:** K3, p to end.

Rep last 2 rows twice more.

Rep these 12 rows  
throughout, patt until piece  
measures same as back to  
underarm, end with a WS  
row.

### Shape Armhole

Keeping patt correct, cast off  
6 (7, 7, 8, 9, 9) sts beg next  
RS row.  
Patt 1 row.  
Keeping patt correct, dec 1 st  
at armhole edge next 4 rows,  
then every RS row 4 (5, 6, 6,  
6, 7) times. 38 (39, 41, 43,  
45, 47) sts.

### Shape Neck

**Next Row:** WS - K3, slip these  
3 sts to holder; cast off 7 sts,  
patt to end.

Keeping patt correct, dec 1 st  
at neck edge next 8 (8, 9, 9,  
10, 11) rows, then every other  
row 3 times. 17 (18, 19, 21, 22,  
23) sts.

Patt straight until front  
measures same as back to  
shoulder, end with a WS row.

Cast off loosely the rem  
17 (18, 19, 21, 22, 23) sts for  
shoulder.

Place 1 button marker 2cm  
below the 3 front neck edge  
sts on hold, one marker  
14cm below first marker and  
the rem 3rd marker evenly  
between the first two.

## RIGHT FRONT

With 4.00mm needles, cast on  
52 (55, 58, 61, 64, 67) sts.

**Row 1:** RS - Knit.

**Row 2:** WS - Knit.

Rep last 2 rows twice more.

**Row 7:** RS - Knit.

**Row 8:** P to last 3 sts, k3.

Rep last 2 rows twice more.

Rep these 12 rows  
throughout, patt until piece  
measures same as back  
to underarm, end with a  
RS row, AT SAME TIME,  
work buttonhole opposite  
marker at beg of RS row  
as following: K3, k2tog, yo  
twice, skp; k to end.

### Shape Armhole

Keeping patt (and buttonhole  
placement) correct, cast off 6  
(7, 7, 8, 9, 9) sts beg next WS  
row.

Keeping patt (and buttonhole  
placement) correct, dec 1 st  
at armhole edge next 4 rows,  
then every RS row 4 (5, 6, 6,

## MEASUREMENTS

TO FIT BUST	81	86	91	96	102	107CM
FINISHED FIT	86	91	96	102	107	112CM
GARMENT LENGTH	44	44	45	45	46	46CM

HAND KNIT YARNS by  
*Naturally*  
IT'S PURE  
NEW ZEALAND  
www.naturallyyarns.nz

6, 7) times. 38 (39, 41, 43, 45, 47) sts.

Work 1 row on WS.

### Shape Neck

NR (RS) - K3, slip these 3 sts to holder; cast off 7 sts, patt to end.

Keeping patt correct, dec 1 st at neck edge next 8 (8, 9, 9, 10, 11) rows, then every other row 3 times. 17 (18, 19, 21, 22, 23) sts.

Patt straight until front measures same as back to shoulder, end with a RS row. Cast off loosely the rem 17 (18, 19, 21, 22, 23) sts for shoulder.

### MAKING UP

Join shoulder seams.

### ARMHOLE BAND

With RS facing and 4.00mm needles, pick up and k47 (48, 51, 52, 55, 55) sts up armhole edge to shoulder, pick up and k47 (48, 51, 52, 55, 55) sts down armhole edge. 94 (96, 102, 104, 110, 110) sts.

**Next Row:** WS - Knit.

**Next Row:** Knit.

Change to 3.75mm needles.

**Next Row:** Knit.

Cast off loosely in k.

### NECKBAND

With RS facing and 4.00mm needles, slip the right front holder 3 sts to needle as if they have

already been worked, pick up and k39 (40, 41, 42, 43, 43) sts up from neck edge to shoulder, 8 sts down back neck, k the back neck holder 21 (21, 23, 23, 25, 27) sts, pick up and k 8 sts up back neck to shoulder, 39 (40, 41, 42, 43, 43) sts down front neck edge to holder, k the 3 holder sts. 121 (123, 127, 129, 133, 135) sts.

**Next Row:** WS - Knit.

**Next Row:** Knit.

Knit 1 more row.

Cast off loosely in k.

Join sides and armhole bands.

Sew on buttons.

### Wentworth Distributors NZ Ltd

Free phone AU: 1800 150 542

Free phone NZ: 0800 738 998

[www.naturallyyarnsnz.com](http://www.naturallyyarnsnz.com)



# MOHAIR SOCKS

*Lovely and light knee length socks to wear about the house.*

*By Jo Sharp*



## STITCH GUIDE SOCKS

Using 4.50mm double pointed needles, loosely cast on 52 sts. Divide onto 3 needles (18-16-18).

**Round 1:** \* K2tbl, P2 rep from \* to end.

Rep this round for 7.5cm.

**Next Round:** Knit.

Rep this round for a further 7.5cm.

**Next Round:** K1, K2tog, knit to last 3 sts, slip 1, knit 1, pss0, k1.

## SKILL LEVEL



intermediate

## WHAT YOU'LL NEED

### Yarn

3 x 25g balls Jo Sharp Mohair in 601 Clove

### Needles

4.50mm double pointed needles.  
(USA 7) (UK 7)

### Tension

18 sts and 24 rows measured over 10cm (approx 4 in) of Stocking Stitch using 4.50mm needles.

## MEASUREMENTS

ONE SIZE FITS ALL AVERAGE ADULT



Knit 5 rounds.

Rep last 6 rounds, 3 times (44sts).

Cont without shaping until work measures 35cm from beg.

### Heel

Knit the first 11 sts of round onto one needle, slip the last 11 sts of round onto other end of same needle (these 22 sts are for the heel).

Divide remaining sts onto two needles and leave for instep.

Work 21 rows on heel sts in all rows of purl and knit (always slipping the first st purlwise

on a purl row and knitwise on a knit row).

To turn heel K13, k2tog, k1, turn.

P8, p2tog, p1, turn.

K9, k2tog, k1, turn.

P10, p2tog, p1, turn.

K11, k2tog, k1, turn.

Cont as set until all sts are worked onto one needle (15sts). Purl 1 row, dec 1 st at each end (13 sts). Knit back 6 sts (heel is completed).

Slip all instep sts onto one needle again.

Using another needle, knit rem 6 sts of heel, then knit up 12 sts along side of heel. With

a second needle, knit across instep sts. Using a third needle, knit up 12 sts along other side of heel, then rem 7 heel sts (59sts).

Dec for instep as follows;

**Round 1:** Knit.

**Round 2:** First needle, knit to last 4 sts, k2tog, k2. Second needle, knit.

Third needle, K2, sl1, k1, pssso, knit to end.

Rep rounds 1 and 2 until 11sts rem on first and third needles.

Cont without shaping until foot measures 22cm (or length required) from the side of heel where sts were knitted up.

### Shape toe

**Round 1:** First needle, knit to last 3 sts, k2tog, k1. Second needle, k1, sl1, k1, pssso, knit to last 3 sts, k2tog, k1. Third needle, k1,

sl1, k1, pssso, knit to end. Rep this round until 12 sts remain.

Work 1 round without shaping, then first needle of next round.

Slip sts on third needle onto the end of first needle, then graft sts tog.

**Jo Sharp**

[www.josharppatterns.com](http://www.josharppatterns.com)



*Mamre is proud to work with Australian Knitting Magazine. We have recently merged with Catholic Care social services Parramatta and whilst the Homestead is currently closed for renovations we are working closely with Penrith City Council to reopen this historic space for the community to enjoy. Mamre is still a thriving community hub that supports people with a disability, refugee and migrant community as well as youth.*

For further information or to support us please call (02) 9670 5321  
181 Mamre Road, Orchard Hills  
[www.mamre.com.au](http://www.mamre.com.au)



# EASY JUMPER

*Design by Gitta Schrade for Naturally Yarns*



## STITCH GUIDE

### BACK

With 6.00mm needles, cast on 43 (47, 51, 55) sts.

**Row 1:** RS - K1; \*p1, k1; rep from \* to end.

**Row 2:** P1; \*k1, p1; rep from \* to end.

Rib for 3.5 (4, 4.5, 4.5)cm, end with a WS row.

**\*\*Next Row:** RS - Knit.

**Next Row:** WS - Knit.

**Next Row:** RS - Purl.

**Next Row:** WS - Purl.

**Next Row:** RS - P1; \*k1, p1; rep from \* to end.

**Next Row:** K1; \*p1, k1; rep from \* to end.

## SKILL LEVEL



beginner

## WHAT YOU'LL NEED

### Yarn

5, 6, 7, 8 balls 50gm Loyal Chunky 14ply in shade #957

### Needles

5.50mm knitting needles  
6.00mm knitting needles  
Stitch holder

### Tension

14 sts by 20 rows over  
Stocking st on 6mm  
needles to 10cm

HAND KNIT YARNS *by*

*Naturally*  
IT'S PURE  
NEW ZEALAND

[www.naturallyyarnsnz.com](http://www.naturallyyarnsnz.com)

**Next Row:** RS - K1; \*p1, k1; rep from \* to end.

**Next Row:** P1; \*k1, p1; rep from \* to end.

Rep last 4 rows 1 (1, 2, 2) times more\*\*

Stst until piece measures 32 (35, 39, 44)cm from beg, end with a WS row.

Cast off 13 (14, 15, 17) sts beg next 2 rows; leave rem 17 (19, 21, 21) sts on holder for back neck.

### FRONT

Work as for Back until Front measures 27 (30, 34, 39)cm from beg, end with a WS row.

### Shape Neck

**Next Row:** RS - K17 (18, 19, 21) sts; turn, on these sts only (leave rem sts on hold).

Dec 1 st at neck edge next 4 rows.

Stst straight until Front meas same as back to shoulder, end with a WS row.

Cast off rem 13 (14, 15, 17) sts. With RS facing return to sts on hold; slip next 9 (11, 13, 13) sts to holder for front neck; rejoin yarn and k to end of row.

Dec 1 st at neck edge next 4 rows.

Stst straight until Front measures same as back to shoulder, end with a RS row.

Cast off rem 13 (14, 15, 17) sts.

### SLEEVES

With 5.50mm needles, cast on 25 (27, 29, 31) sts.

K1, p1 rib as for back for 3 (3, 3.5, 3.5)cm, end with a WS row. Change to 6.00mm needles.

Stst and inc 1 st each end every 4th (5th, 4th, 4th) row to 37 (39, 45, 51) sts.

### MEASUREMENTS

SIZE	2	4	6	8YEARS
<b>FINISHED FIT</b>	<b>61</b>	<b>66</b>	<b>71</b>	<b>77CM</b>
GARMENT LENGTH	32	35	39	44CM
<b>SLEEVE LENGTH</b>	<b>24</b>	<b>27</b>	<b>30</b>	<b>34CM</b>

Cont straight until sleeve measures 18 (21, 22, 26)cm from beg, end with a WS row. Work as for Back from \*\* to \*\*. Cast off loosely. Join left shoulder seam.

### NECKBAND

With RSF and 5.5mm needles, k the back neck holder 17 (19, 21, 21) sts, pick up and k13 sts down front neck, k the front neck holder 9 (11, 13, 13) sts, pick up and k13 up front neck edge to shoulder - 52 (56, 60, 60) sts.

NR (WS) - Knit.  
NR (RS) - Purl.

NR (WS) - Purl.

K1, p1 rib for 4 rows. Cast off loosely in rib.

### MAKING UP

Join right shoulder seam and neckband.

Place markers 14 (15, 17, 18) cm down from shoulders on back and front.

Insert sleeve tops between markers.

Join side and sleeve seams.

**Wentworth Distributors NZ Ltd**  
Free phone AU: 1800 150 542  
Free phone NZ: 0800 738 998  
[www.naturallyyarnsnz.com](http://www.naturallyyarnsnz.com)

# Raphaël

The name says it all...

Australian Agent:  
**Heidelberg**  
Fine Art  
Wholesalers



For the full range of products, visit [www.hfaw.com](http://www.hfaw.com)



Manufactured in France since 1793, Raphael brushes are the finest quality brushes in the world.



Available throughout Australia - ring for your nearest stockist!

### Raphael Mongoose

Synonymous with fine oil painting where blending and layering are essential. These brushes are especially good for glazing and for modifying existing colour areas to create soft, gradual transitions.

Agents: HFAW, PO Box 64, Fitzroy, Vic. 3065 Ph: (03) 9419 5559 Fax: (03) 9419 4232 email: [hfaw@bigpond.net.au](mailto:hfaw@bigpond.net.au)

# LUCY LOU

*This plain or patterned sweater features bobble edging on the cuff, collar and band.  
The patterned versions have a striped bodice and Lazy Daisy embroidered flowers on the sleeve.*

## STITCH GUIDE COLOUR SEQUENCES BODICE, VERSION 2

Working in st st.

Rows 1-2: col B,

Row 3: col C,

Row 4: col B,

Row 5: col D,

Row 6: col A,

Row 7: col E,

Row 8: col F,

Rows 9 - 11: col A.

Repeat these 11 rows throughout.

## SLEEVES, VERSIONS 2

Working in st st

Rows 1- 4: col A,

Rows 5: col C,

Row 6: col F,

Row 7: col C,

Rows 8 - 11: col A,

Rows 12 - 17: col E.

Rep rows 1 - 17.

## FRONT

Using 3.75mm needles and col A, cast on 82(86,90)sts.

\*\*Knit 5 rows. Purl 1 row.

**Bobble Row:** RS - K2,\*MB, k3; rep from \* to end.

Purl 1 row. Knit 4 rows.

Change to 4.50mm needles\*\*.

Now work in Colour Sequence (above) until front bodice (incl. band) measures 40.5(44.5, 48.5) cm, ending on a WS row.

## Shape neck

RS -Work 35(37, 39) sts, turn and leave rem 47(49, 51) sts on a holder.

Work each side of neck separately.

Dec 1st at beg (neck edge) on every row, 4 times, then every foll alt row, 4 times. 27(29, 31) sts

(13 shaping rows). Work 3 rows straight.

## Shape Shoulders

RS - Cast off 9(10, 10) sts at beg next and foll alt rows once. Work 1 row. Cast off rem 9(9, 11) sts.

Leave 12 centre sts on holder.

Rejoin yarn to rem sts. Work second side to match first side, rev all shaping.

## BACK

Work back bodice to match front bodice, omitting neck shaping and working shoulder shaping into last 6 rows as follows:

## Shape Shoulders

Cast off 9(10, 10) sts at beg next 4 rows, then 9(9, 11) sts at beg next 2 rows.

Cast off rem 28 sts.

## SLEEVES

Using 3.75mm needles and col A, cast on 38(42, 46) sts. Work as for front from \*\* to \*\*.

## Shape sleeve

Now working in colour sequence for sleeves, at the same time inc 1st each end

next row, then 1st each end foll 5th rows, 10(11, 13) times, then foll 6th rows 4(5, 5) times. 68(76, 84) sts 75(86, 95) shaping rows.

Work 7(5, 1) rows straight. Cast off.

## MAKING UP

Embroider sleeves

Using cols B, C and D, embroider Lazy Daisies onto sleeves (as illustrated in colour images) using col F for centres of flowers.

Press all pieces gently on WS with a warm iron over a damp cloth. Using Backstitch, join right shoulder seams.

## Neckband

With RS facing, using 3.75mm needles and col A, pick up and knit 18(20, 22) sts along left front, 12 sts from stitch holder at centre front, 18(20, 22) sts

MEASUREMENTS			
SIZE	5-6	7-8	9-10
TO FIT CHEST	62-66	67-71	72-76CM
FINISHED FIT	82	86	90CM
GARMENT LENGTH	48	52	56CM
SLEEVE LENGTH	35	38.5	40.5CM
BEANIE CIRCUMFERENCE	47CM		

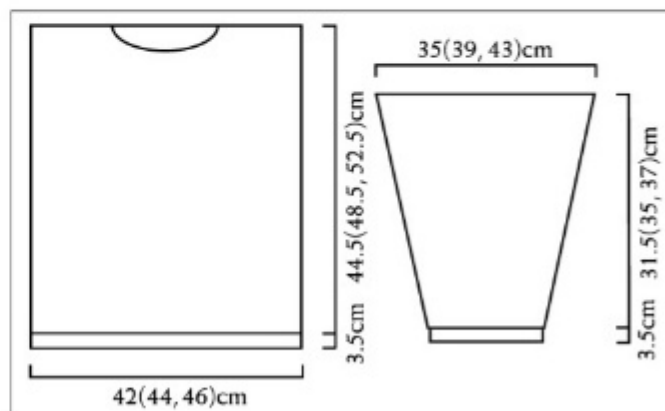

## SKILL LEVEL



## WHAT YOU'LL NEED

### Yarn

3, 3, 4 balls 50gm Jo  
Sharp DK 8ply colour A  
Ink 901 (Denim 362)  
2, 2, 2, balls 50gm Jo  
Sharp DK 8ply colour B  
Storm 706 (Navy 327)  
1, 2, 2 balls 50gm Jo  
Sharp DK 8ply colour C  
Orchard 906 (Orchard  
906)  
1, 1, 1 balls 50gm Jo  
Sharp DK 8ply colour D  
Heron 802 (Heron 802)  
2, 2, 2 balls 50gm Jo  
Sharp DK 8ply colour  
E Embers 804 (Flame  
363)  
1, 1, 2 balls 50gm Jo  
Sharp DK 8ply colour F  
Miro 507 (Moon 358)

Beanie: 2 balls 50gm Jo  
Sharp DK 8ply colour in  
Storm 706 (Navy 327)

### Needles

3.75mm knitting needles  
4.50mm knitting needles

### Tension

19.5 sts by 26 rows over  
stocking st on 4.50mm  
needles to 10cm

### Special abbreviations

Make Bobble (MB)  
K1,p1,k1,p1,k1 in next st  
(5sts made), pass 1st,  
2nd, 3rd and 4th sts over  
last st made.



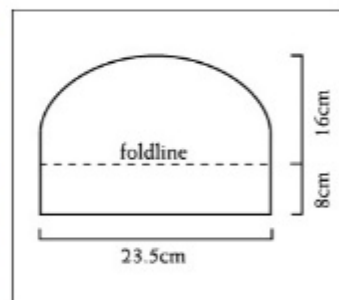

### BEANIE

Using 3.75mm needles, cast on 107 sts and work 8cm in Moss st, ending on a WS row. Change to 4.00mm needles. Now work in st st until work (from beg) measures 16cm.

**Row 1:** Shape top RS - K1, k2tog, (k23, k3tog tbl) 3 times, k23, k2tog tbl, k1. 99sts.

**Row 2:** Purl one row.

**Row 3:** K1, k2otg, (k21, k3tog tbl) 3times, k21, k2tog tbl, k1. 91sts.

**Row 4:** Purl 1 row.

**Row 5:** K1, k2otg, (k19, k3tog tbl) 3times, k19, k2tog tbl, k1. 83sts.

Purl 1 row. Cont decreasing 8 sts in each RS row until 43sts rem.

**Next Row:** WS - P1, p2tog tbl, (p7, p3tog tb) 3 times, p7, p2tog, p1. 35sts.

Cont decreasing 8 sts every row until 11 sts rem.

Break yarn and thread through 11 rem sts, pull thread tightly and secure.

Sew seam using Edge to Edge stitch.

Fold back brim.

**Jo Sharp**

[www.josharpatterns.com](http://www.josharpatterns.com)

along right front and 26 sts across back neck. 74(78, 82) sts.

Knit 4 rows. Purl 1 row.

**Bobble Row:** RS - K2, \* MB, k3; rep from \* to end.

Purl 1 row.

Knit 4 rows. Cast off.

Join neckband seam and left shoulder. Centre sleeves and join. Join side and sleeve seams. Press seams.

### MOSS STITCH BEANIE

**Row 1:** RS - K1, p1.

**Row 2:** WS - Knit the purl sts and purl the knit sts, as they face you.

Rows 1 and 2 form pattern.

# TOP KNOT BEANIE

*Design by Charmaine Connell for Naturally Yarns*

## STITCH GUIDE

### BEANIE

With 3.75mm needles, cast on 67 (73, 79, 85, 91, 97) sts.

Stocking st 6 rows.

**Next Row:** RS - K1; \*p1, k1; rep from \* to end.

**Next Row:** WS - P1; \*k1, p1; rep from \* to end.

Rib 4 more rows.

Change to 4.00mm needles. Cont in Stocking st until hat measures 10 (11, 11, 12, 13, 14) cm from beg of rib, end with a WS row.

### Shape Top

**Next Row:** RS - \*K4, k2tog;

rep from \* to last st, k1. 56 (61, 66, 71, 76, 81) sts.

Beg with a p row on WS, Stst for 3 rows.

**Next Row:** RS - \*K3, k2tog; rep from \* to last st, k1. 45 (49, 53, 57, 61, 65) sts.

Beg with a p row on WS, Stst for 3 rows.

**Next Row:** RS - \*K2, k2tog; rep from \* to last st, k1. 34 (37, 40, 43, 46, 49) sts.

**Next Row:** P.

**Next Row:** RS - \*K1, k2tog; rep from \* to last st, k1. 23 (25, 27, 29, 31, 33) sts.

**Next Row:** P.

**Next Row:** RS - \*K2tog; rep

from \* to last st, k1. 12 (13, 14, 15, 16, 17) sts.

**Next Row:** WS - P0 (1, 0, 1, 0, 1); \*p2tog; rep from \* to end. 6 (7, 7, 8, 8, 9) sts.

### Sizes 6-9 months (9-12 months, 1-2 years) ONLY

**Next Row:** RS - K and dec 1 (1, 2) sts. 7 (7, 7) sts. P 1 row.

### MAKE STALK

All sizes.

Stst over these rem 6 (7, 7, 7, 7) sts for 7cm, end with a WS row.

Break yarn, leaving longer end.

Thread end through rem sts and pull together, secure, use rem end to sew up back of stalk, then join back of beanie. Knot stalk.

### Wentworth Distributors NZ Ltd

Free phone AU: 1800 150 542  
Free phone NZ: 0800 738 998  
[www.naturallyyarnsnz.com](http://www.naturallyyarnsnz.com)

## SKILL LEVEL



beginner

## WHAT YOU'LL NEED

### Yarn

1, 1, 1, 1, 1, 2 balls 50gm Classic Prints DK 8ply in shades #876 & 878

### Needles

3.75mm knitting needles  
4.00mm knitting needles

### Tension

22 sts by 30 rows over Stocking Stitch on 4mm needles to 10cm

### Special abbreviations

M1 – k into back of strand between last st worked and next st;

HAND KNIT YARNS by

*Naturally*  
IT'S PURE  
NEW ZEALAND

[www.naturallyyarnsnz.com](http://www.naturallyyarnsnz.com)



### MEASUREMENTS

SIZE	NEWBORN	3	3-6	6-9	9-12	1-2 YEARS
FINISHED FIT HEAD	33	35	37	39	41	43CM

# STRIPED HOODIE

*Design by Sandi Prosser for Filatura Di Crosta*

## STITCH GUIDE

### MAIN STRIPE PATTERN

Working in Stst, change colours as following \*8 rows MC, 4 rows A; rep from \* throughout.

### SLEEVE STRIPE PATTERN

Working in Stst, change colours as following \*4 rows MC, 4 rows A, 4 rows MC, 4 rows B; rep from \* throughout.

### BACK

With 3.75mm needles and MC, cast on 62 (70, 78, 82) sts.

Break MC and join B.

**Row 1:** RS - With B, k2, \*p2, k2; rep from \* to end.

**Row 2:** With B, p2, \*k2, p2; rep from \* to end.

Work a further 6 (6, 8, 8) rows in rib and dec 4 (6, 8, 6) sts evenly across last row. 58 (64, 70, 76) sts.

Change to 4.00mm needles. Starting with a knit (RS) row, work in Main Stripe Pattern until piece measures 26.5 (29, 34, 38)cm from beg, end with a WS row.

### Shape Shoulders

Cast off 10 (11, 12, 13) sts at beg of next 2 rows, 11 (12, 13, 14) sts at beg of next 2 rows. Leave rem 16 (18, 20, 22) sts on holder.

### RIGHT FRONT

With 3.75mm needles and MC, cast on 30 (33, 37, 40) sts.

Break MC and join B.

**Row 1:** RS - With B, k2 (1, 1, 0), \*p2, k2; rep from \* to end.

**Row 2:** With B, \*p2, k2; rep from \* to last 2 (1, 1, 0) sts, p2 (1, 1, 0).

Work a further 6 (6, 8, 8) rows in rib and dec 3 (3, 4, 4) sts evenly across last row. 27 (30, 33, 36) sts.

Change to 4.00mm needles. Starting with a knit (RS) row, work in Main Stripe Pattern until piece measures 23 (25.5, 29, 33)cm from beg, end with a WS row.

### Shape Neck

**Next Row:** RS - Cast off 3 (4, 4, 5) sts, knit to end of row. Cont in Main Stripe patt, dec 1 st at neck edge every row 3 times, then every other row 0 (0, 1, 1) times. 21 (23, 25, 27) sts.

Work even in Main Stripe patt until piece measures 26.5 (29, 34, 38)cm from beg, end with a RS row.

### Shape Shoulder

Cast off 10 (11, 12, 13) sts at beg of next row. Work 1 row even. Cast off rem 11 (12, 13, 14) sts.

### LEFT FRONT

With 3.75mm needles and MC, cast on 30 (33, 37, 40) sts.

Break MC and join B.

**Row 1:** RS - With B, \*k2, p2; rep from \* to last 2 (1, 1, 0) sts, k2 (1, 1, 0).

**Row 2:** With B, p2 (1, 1, 0), \*k2, p2; rep from \* to end.

Work a further 6 (6, 8, 8) rows in rib and dec 3 (3, 4, 4) sts evenly across last row. 27 (30, 33, 36) sts.

Change to 4.00mm needles. Starting with a knit (RS) row, work in Main Stripe Pattern until piece measures 23 (25.5, 29, 33)cm from beg, end with a RS row.

### Shape Neck

**Next Row:** WS - Cast off 3 (4, 4, 5) sts, knit to end of row. Cont in Main Stripe patt, dec 1 st at neck edge every row 3 times, then every other row 0 (0, 1, 1) times. 21 (23, 25, 27) sts.

Work even in Main Stripe patt until piece measures 26.5 (29, 34, 38)cm from beg, end with a WS row.

### Shape Shoulder

Cast off 10 (11, 12, 13) sts at beg of next row. Work 1 row even. Cast off rem 11 (12, 13, 14) sts.

**Row 2:** With B, p2, \*k2, p2; rep from \* to end.

Work a further 4 (4, 6, 6) rows in rib, inc 2 (0, 2, 0) sts evenly across last row. 36 (38, 40, 42) sts.

Change to 4.00mm needles. Starting with a knit (RS) row, work in Sleeve Stripe Pattern and inc 1 st each end of 5th and every following 8th (8th, 6th, 6th) row to 46 (50, 54, 60) sts.

Work even until Sleeve measures 20.5 (21.5, 23, 28) cm from beg, end with a WS row.

### Shape Top

Cast off 8 (8, 7, 7) sts at beg of next 4 (4, 6, 6) rows. Cast off rem 14 (18, 12, 18) sts.

### MAKING UP

Block pieces to measurements. Sew shoulder seams.

### HOOD

With RS facing, 4.00mm needles and MC, beg at right front neck edge, pick up and k18 (19, 24, 24) sts up neck edge, k the back neck holder 16 (18, 20, 22) sts, pick up and k 18 (19, 24, 24) sts down left front neck edge. 52 (56, 68, 70) sts.

Working in Main Stripe Pattern, proceed as follows:

**Row 1:** WS - Purl.

**Row 2:** inc row - K15 (17, 23, 24), (M1, k2) 11 times, M1, k15 (17, 23, 24). 64 (68, 80, 82) sts.

## MEASUREMENTS

SIZE	12	18MTH	2	4 YEARS
<b>FINISHED FIT</b>	<b>53</b>	<b>58</b>	<b>64</b>	<b>68CM</b>
GARMENT LENGTH	26.5	29	34	38CM
<b>SLEEVE LENGTH</b>	<b>20.5</b>	<b>21.5</b>	<b>23</b>	<b>28CM</b>

### SLEEVES

With 3.75mm needles and MC, cast on 34 (38, 38, 42) sts. Break MC and join B.

**Row 1:** RS - With B, k2, \*p2, k2; rep from \* to end.



## SKILL LEVEL



intermediate

## WHAT YOU'LL NEED

### Yarn

3, 3, 4, 5 balls 50gm  
Zara extra fine Merino  
Wool main colour in  
shade #1389  
1, 2, 2, 2 balls 50gm  
Zara extra fine Merino  
Wool colour A in shade  
#1396  
1, 1, 2, 2 balls 50gm  
Zara extra fine Merino  
Wool colour B in shade  
#4002  
Open end zip of  
matching colour

### Needles

3.75mm knitting needles  
4.00mm knitting  
needles  
3.75mm circular needle,  
80cm long  
Stitch holders

### Tension

22 sts by 30 rows over  
Stocking st on 4mm  
needles to 10cm

### Special abbreviations

skp – slip 1 stitch, k 1  
stitch, pass slipped st  
over;  
M1 - make 1 stitch -  
pick up running thread  
from front to back, k it  
through the back loop

HAND KNIT YARNS by

*Naturally*  
IT'S PURE  
NEW ZEALAND

[www.naturallyyarnsnz.com](http://www.naturallyyarnsnz.com)





**Row 3:** Purl.

**Row 4:** inc row - K17 (19, 25, 26), (M1, k3) 10 times, M1, k17 (19, 25, 26). 75 (79, 91, 93) sts. Work even in Main Stripe patt until piece measures 16.5 (18, 20.5, 21.5)cm from beg, end with a WS row.

**Shape Top**

Cast off 25 (26, 30, 31) sts at beg of next 2 rows. 25 (27, 31, 31) sts.

Cont even in Main Stripe patt until hood measures 11.5 (12, 13.5, 14)cm from cast off sts, end with a WS row and dec 1 st at centre of last row to 24 (26, 30, 30) sts. Leave these

rem sts on hold.

Join side edges at top of hood to cast off sts.

**CENTRE FRONT ZIP/ HOOD EDGING**

With RS facing, 3.75mm circular needle and B, pick up and k 61 (67, 77, 87) sts evenly up right front edge to start of hood, 43 (46, 52, 56) sts along side of hood, k the 24 (26, 30, 30) sts from holder, pick up and k 43 (46, 52, 56) sts down side of hood, 61 (67, 77, 87) sts evenly down left front edge. 232 (252, 288, 316) sts. Do not join.

**Rows 1 and 3:** WS - K1, \*p2, k2; rep from \* to last 3 sts, p2, k1.

**Row 2:** K3, \*p2, k2; rep from \* to last st, k1.

Cast off all sts in rib.

Fold sleeves in half, placing fold at shoulder seams and sew sleeves in position.

Sew side and sleeve seams.

Sew zip under zip edging; beg at lower edge and ending at start of neck shaping.

**Wentworth Distributors NZ Ltd**  
Free phone AU: 1800 150 542  
Free phone NZ: 0800 738 998  
[www.naturallyyarnsnz.com](http://www.naturallyyarnsnz.com)

# SENNELIER

*Sennelier watercolours are wonderful!*



Sennelier watercolours were first manufactured in Paris in the late 19th century to meet the demands of the increasingly expressive talents of the French artists at that time who were engaged in capturing the impressions of night life, daily activities and climatic changes of Paris as well as the countryside in the south of France.



*Available throughout Australia - ring for stockists!*

*There are many pigments, such as Japanese Orange, that are unique to the Sennelier 80-colour range.*



Sennelier watercolours are available in both tubes and half pans.

Unlike other European watercolours which reflect the cooler tones of their countries through greens and browns, Sennelier have an extended range of warm tones in reds, yellows and oranges that work so well with our warm Australian desert and beach tones.

**Agents: HFAW, PO Box 64, Fitzroy, Vic. 3065 Ph: (03) 9419 5559 Fax: (03) 9419 4232 email: hfaw@bigpond.net.au**

# LITTLE COTTON HAT

*An easy to knit hat with a moss stitch band. By Jo Sharp*

## SKILL LEVEL



## WHAT YOU'LL NEED

### Yarn

2 x 50g balls Desert  
Garden Aran 207  
Nightsky

### Needles

4.50mm knitting  
needles  
5.00mm knitting  
needles

### Tension

18 sts by 24 rows on  
5mm needles to 10cm

## MEASUREMENTS

CIRCUMFERENCE - 47CM



## STITCH GUIDE

### Moss Stitch

**Row 1:** K1, P1 to end of row.  
**Row 2:** K1, P1 to end of row.

### HAT

Using 4.50mm needles, cast on 85 sts.  
Work in Moss st for 3cm, ending on a WS row.  
Change to 5.00mm needles.

Work 10cm in st st, beg with a RS row and ending on a WS row.

### Shape top

**Row 1:** RS - K2, k2tog, (k17, k3tog tbl) 3 times, k17, k2tog tbl, k2. 77 sts.  
Purl 1 row.

**Row 3:** K2, k2tog, (k15, k3tog tbl) 3 times, k15, k2tog tbl,

k2. 69 sts.

Purl 1 row.

**Row 5:** K2, k2tog, (k13, k3tog tbl) 3 times, k13, k2tog tbl, k2. 61 sts.

Purl 1 row.

Cont to dec 8 sts every RS row until 37 sts rem.

**Next Row:** W- P2, p2tog tbl, (p5, p3tog tbl) 3 times, p5, p2tog, p7. 29 sts.

Cont to dec 8 sts every row until 13 sts rem.

**Next Row:** K1, \* k2tog, rep from \* to end. 7 sts.

Break yarn and thread through rem sts, pull tight and secure.  
Sew seam using edge to edge st.

**Jo Sharp**

[www.josharppatterns.com](http://www.josharppatterns.com)

# CARDIGAN WITH EYELET PATTERN

*Design by Patons Bluebell in a 5ply*

## SKILL LEVEL



intermediate

## WHAT YOU'LL NEED

### Yarn

8, 9, 10, 11 balls 50gm  
Patons Bluebell 5ply in  
Byzantium #4368  
7 buttons

### Needles

3.75mm knitting needles  
3.00mm knitting needles  
3.75mm circular knitting  
needle 80cm  
3.00mm circular knitting  
needle 80cm  
Wool sewing needle

### Tension

26 sts by 35 rows over  
stocking st, on 3.75mm  
needles to 10cm

### Special abbreviations

M1 = make one – pick  
up loop which lies before  
next st, place on left-  
hand needle and knit into  
back of loop.

## STITCH GUIDE CARDIGAN (WORKED IN ONE PIECE TO ARMHOLES)

Using 3.00mm circular  
needle, cast on 211 (231, 251,  
271) sts.

NOTE – A circular needle has  
been used to accommodate  
the large number of sts. Work  
backwards and forwards in  
rows not rounds. If desired,  
change to pair of needles after  
dividing for Back and Fronts.

Row 1: K2, \* P1, K1, rep from \*  
to last st, K1.

Row 2: K1, \* P1, K1, rep from  
\* to end.

Rep 1st and 2nd rows 4 times.  
10 rows rib in all.

Change to 3.75mm circular  
needle.

### Beg Patt

Row 1: Knit.

Row 2 and foll alt: Purl.

Row 3: K3, K2tog, yfwd, K1,  
yfwd, sl 1, K1, pssso, \* K2tog,  
yfwd, rep from \* to last 9 sts,  
K1, K2tog, yfwd, K1, yfwd, sl 1,  
K1, pssso, K3.

Row 5: K3, K2tog, yfwd, K1,  
yfwd, sl 1, K1, pssso, knit to last  
8 sts, K2tog, yfwd, K1, yfwd, sl  
1, K1, pssso, K3.

Row 7: As 3rd row.

Row 9, 11 and 13: As 5th row.

Row 15 and 17: K3, K2tog,  
yfwd, K1, yfwd, sl 1, K1, pssso,

\* K2tog, yfwd, K1, yfwd, sl 1,  
K1, pssso, K5, rep from \* to last  
13 sts, (K2tog, yfwd, K1, yfwd,  
sl 1, K1, pssso) twice, K3.

Row 19, 21 and 23: As 5th row.

Row 25 and 27: K3, K2tog,  
yfwd, K1, yfwd, sl 1, K1, pssso,

\* K5, K2tog, yfwd, K1, yfwd, sl  
1, K1, pssso, rep from \* to last  
13 sts, K5, K2tog, yfwd, K1,  
yfwd, sl 1, K1, pssso, K3.

Row 28: As 2nd row.

Rows 9 to 28 incl form patt  
for rem.

Cont in patt until work  
measures 36cm from beg,  
working last row on wrong side.

### Divide for Back and Fronts

NOTE – Care must be taken  
when shaping in this lacy  
patt. Do not work a K2tog  
or sl 1, K1, pssso, unless the  
corresponding yfwd can be  
worked and vice versa.

Next Row: Patt 8, sl 1, K1, pssso  
(Right Front edge dec), patt  
37 (41, 44, 47), cast off next 12  
(14, 18, 22) sts, patt 93 (101,  
107, 113) incl st rem on right-  
hand needle after casting off,  
cast off next 12 (14, 18, 22) sts,  
patt to last 10 sts, K2tog (Left  
Front edge dec), patt to end.  
Cont on last 46 (50, 53, 56)  
sts for Left Front.

Keeping patt correct, dec  
one st at armhole edge in  
every foll alt row 6 (8, 10, 11)

times, at same time dec one  
st (inside 8 sts as before) at  
front edge in every foll 4th  
row 11 (9, 10, 11) times, then in  
every foll 6th row until 26 (28,  
28, 29) sts rem.  
Work 5 rows.

### Shape Shoulder

Cast off 9 (9, 9, 10) sts at beg  
of next row and foll alt row.  
Work 1 row. Cast off rem 8 (10,  
10, 9) sts.

With wrong side facing, join  
yarn to next group of 93 (101,  
107, 113) sts for Back.  
Keeping patt correct, dec one  
st at each end of every foll alt  
row until 81 (85, 87, 91) sts rem.  
Work 55 (55, 55, 57) rows.

### Shape Shoulders

Cast off 9 (9, 9, 10) sts at beg  
of next 4 rows, then 8 (10, 10,  
9) sts at beg of foll 2 rows.  
Cast off rem 29 (29, 31, 33) sts.  
With wrong side facing, join  
yarn to rem 46 (50, 53, 56) sts  
for Right Front.

Keeping patt correct, dec  
one st at armhole edge in  
every foll alt row 6 (8, 10, 11)  
times, at same time dec one  
st (inside 8 sts as before) at  
front edge in every foll 4th  
row 11 (9, 10, 11) times, then in  
every foll 6th row until 26 (28,  
28, 29) sts rem.  
Work 6 rows.

 Patons

### Shape Shoulder

Cast off 9 (9, 9, 10) sts at beg of next row and foll alt row. Work 1 row. Cast off rem 8 (10, 10, 9) sts.

### SLEEVES

Using 3.00mm needles, cast on 51 (51, 53, 53) sts. Work 8 rows rib as for Back. Change to 3.75mm needles.

### Beg Patt

**Row 1:** Knit.

**Row 2:** Purl.

**Row 3:** \* K2tog, yfwd, rep from \* to last st, K1.

**Row 4:** Purl.

Rep rows 1 to 4 incl once.

**Next Row:** K2, M1, knit to last 2 sts, M1, K2. 53 (53, 55, 55) sts.

Working in stocking st for rem, inc one st (as before) at each end of every foll 12th (8th, 6th, 6th) row until there are 69 (71, 57, 85) sts, then in every foll 14th (10th, 8th, 8th) row until there are 71 (79, 83, 91) sts.

Cont without further shaping until Sleeve measures 43cm from beg, ending with a purl row.

### Shape Top

Cast off 3 (4, 5, 5) sts at beg of next 2 rows. 65 (71, 73, 81) sts.

Dec one st at each end of next row, then in every foll alt row until 15 (23, 23, 35) sts rem, then in every row until 13 sts rem. Cast off.

### FRONT BAND

Join shoulder seams.

Using 3.00mm needles, cast on 9 sts.

Work 2 rows rib as for Back.

**Row 3:** Rib 4, cast off 2 sts, rib 3.

**Row 4:** Rib 3, turn, cast on 2 sts, turn, rib 4. buttonhole. Work 16 rows rib.

Rep last 18 rows 5 times, then buttonhole rows once. 7 buttonholes.

Cont in rib until front band is length required to fit (slightly stretched) evenly along front edges and across back neck. Cast off in rib.

### MAKING UP

With a slightly damp cloth and warm iron, press lightly. Join sleeve seams. Sew in sleeves evenly. Sew front band in position, placing buttonholes to right front edge. Sew on buttons.

### Patons

Ph: 1800 337 032

[www.patonsyarns.com.au](http://www.patonsyarns.com.au)

### MEASUREMENTS

SIZE	XS	S	M	L
<b>TO FIT BUST</b>	<b>70</b>	<b>80</b>	<b>90</b>	<b>100CM</b>
FINISHED FIT	82	90	98	106CM
<b>GARMENT LENGTH</b>	<b>54</b>	<b>55</b>	<b>56</b>	<b>57CM</b>
SLEEVE LENGTH	43CM			



# GARTER STITCH SHAWL-VEST

*Design by Gitta Schrade for Naturally Yarns*



## MEASUREMENTS

SIZE	S	M	L	X-L
<b>FINISHED BUST WHEN OVERLAPPED AT FRONT</b>	<b>92</b>	<b>102</b>	<b>112</b>	<b>122CM</b>
APPROX LENGTH TO SHOULDER	50	52	54	56CM

## GETTING STARTED

Worked sideways and begins at right front edge.

## WORKING PATTERN BODY

With 5.50mm needles, cast on 114 (117, 120, 123) sts. Ensure to mark RS.

Garner Stitch (knit every row) for 33 (36, 39, 42)cm, end with a WS row.

Place marker at end of last row (neck/collar edge).

Shape 1st Armhole

### Next Row:

RS - K38 sts, cast off loosely 33 (35, 36, 37) sts, k to end.

Next Row: WS - K43 (44, 46, 48) sts (leave the upper rem 38 sts unworked for now).

Garner Stitch over these 43 (44, 46, 48) sts for 3 more rows.

Next Row: WS - K43 (44, 46, 48) sts; cast on 33 (35, 36, 37) sts, k rem 38 sts. 114 (117, 120, 123) sts.

Garner Stitch straight until piece measures 46 (51, 56, 61)cm from marker, end with a WS row.

### Shape 2nd Armhole

Next Row: RS - K38 sts, cast off loosely 33 (35, 36, 37) sts, k to end.

Next Row: WS - K43 (44, 46, 48) sts (leave the upper rem 38 sts unworked for now).

Garner Stitch over these 43 (44, 46, 48) sts for 3 more rows.

Next Row: WS - K43 (44,

46, 48) sts; cast on 33 (35, 36, 37) sts, k rem 38 sts. 114 (117, 120, 123) sts.

Place marker at end of last row (neck/collar edge).

Garner Stitch straight until piece measures 33 (36, 39, 42)cm from last marker, end with a WS row.

Cast off loosely.

Break yarn, weave in ends.

## MAKING UP

Fold collar section down and out over shoulders when wearing.

Use pin and/or belt for closure.

## Wentworth Distributors NZ Ltd

Free phone AU: 1800 150 542

Free phone NZ: 0800 738 998

[www.naturallyyarns.nz.com](http://www.naturallyyarns.nz.com)

## SKILL LEVEL



intermediate

## WHAT YOU'LL NEED

### Yarn

4, 4, 5, 5 balls 100gm Crazy Mohair in shade #2039

1 Pin - Paradise Pin SP23603

### Needles and tools

5.50mm knitting needles  
Stitch markers

### Tension

15 sts over Garner Stitch on 5.50mm needles 10cm



JO SHARP

mulberry silk georgette

Spend \$19 or more on digital patterns at [josharppatterns.com](http://josharppatterns.com) and get 50% off. To receive this discount, use the discount code **pattern50** at the checkout (available until June 2016)

This garment #307 Scoop Cardigan digital download.

Shop for yarn at the outlets listed below. Shade: 770 Watermelon

Find Jo Sharp pattern collections & knitting yarns at the following outlets: **ACT** **Manuka** The Wool Shed@Manuka, 02 6295 0061 [www.woolshed.com.au](http://www.woolshed.com.au), **NSW** **Beecroft** Yarn & Gifts 02 8407 9512, **Penrith** The Wool Inn 02 4732 2201 [www.the-wool-inn.com](http://www.the-wool-inn.com), **Guyra** Black Sheep Wool 'n' Wares 02 6779 1196 [www.blacksheepwool.com.au](http://www.blacksheepwool.com.au), **Hornsby** Hornsby Wool & Craft 02 9482 4924, **Thirroul** Knitting for the Soul 0421 580 730 [www.knittingforthesoul.com.au](http://www.knittingforthesoul.com.au), **Mittagong** Victoria House Needle Craft 02 4871 1682 [www.victoriahouseneedlecraft.com.au](http://www.victoriahouseneedlecraft.com.au) **Mudgee** Classic Treasures 02 6372 7626 [www.classictreasures.com.au](http://www.classictreasures.com.au) **Punchbowl** Wool and Yarn (online only) 0425 227 885 [www.woolandyarn.com.au](http://www.woolandyarn.com.au) **Wollombi** The Woolombi Wool Store 02 4998 3153 [www.woolombiwoolstore.com.au](http://www.woolombiwoolstore.com.au), **Merimbula** Pins & Needles 02 6495 3646 [pinsneedles.allthingsquilting.com.au](http://pinsneedles.allthingsquilting.com.au), **Newcastle** Hand to Hand Crafts 02 4929 7255, **Rylstone** Convent & Chapel 0409 564 747 [www.conventandchapel.com](http://www.conventandchapel.com) **QLD** **Canungra** My Country Escape 07 5543 4042 [www.facebook.com/MyCountryEscape](http://www.facebook.com/MyCountryEscape), **Dickles Beach** Kochies Yarn 0418 549 217 [www.kochiesyarn.com.au](http://www.kochiesyarn.com.au), **SA** **Glenelg** Barb's Sew & Knits 08 8294 7441 [www.barbssewandknits.com.au](http://www.barbssewandknits.com.au), **Highgate** Needle Nook 08 8271 4670 [www.needlenook.com.au](http://www.needlenook.com.au) **St Agnes** House Of Yarn 08 8263 9544 [www.houseofyarn.com](http://www.houseofyarn.com), **Brooklyn Park** Purl and Friends 0433 02 2016 **TAS** **Hobart** The Stash Cupboard 03 6234 1219 [www.facebook.com/TheStashCupboard](http://www.facebook.com/TheStashCupboard), **Deloraine** The Alpaca Shoppe 0457 198 753 [www.facebook.com/TheAlpacaShoppe](http://www.facebook.com/TheAlpacaShoppe) **VIC** **Canterbury** Sunspun 03 9830 1609 [www.sunspun.com.au](http://www.sunspun.com.au), **Healsville** Crumbz 0412 389 192 [www.crumbz.com.au](http://www.crumbz.com.au), **Lonsdale** Wild Purl 03 5258 5349, **Mansfield** Country Folk Craft, Art & Gifts 03 5775 2044 [www.countryfolk.com.au](http://www.countryfolk.com.au), **Northcote** Woolarium 03 9486 5275 [www.woolarium.com](http://www.woolarium.com), **Sassafras** Dalcheri Uniquely Ethical 03 9755 2510 [www.dalcheri.com.au](http://www.dalcheri.com.au) **WA** **Albany** Knit Online Store (online only) [www.knit.net.au](http://www.knit.net.au) 0898 414640,

# SOMERVILLE SWEATER

*A loose fitting sweater with an elegantly classic shaped sleeve top and neckline.*

*Worked in Jo Sharp's Desert Garden Aran Cotton.*

## WORKING PATTERN

### FRONT

Using 4.00mm needles, cast on 86(92, 102, 110)sts. Work 3cm st st, ending on a WS row. Change to 5.00mm needles. Cont working in st st until bodice length (incl band) measures 34cm, ending on a WS row.

### Shape armholes

RS – Cast off 3 sts at beg next 2 rows.  
Next Row: RS dec - K2, k3tog, k to last 5 sts, k3tog tbl, k2. This row sets patt for decreasing. Cont working in st st, dec 2 sts at each end of foll 4th rows, 3 times.  
Work 11 rows.  
Next Row: RS – K3tog, work to last 3 sts, k3tog tbl (60(66,76,84)sts, 27 shaping rows).  
Cont working straight until bodice length (incl band) measures 46.5(46.5, 48.5, 48.5)cm, ending on a WS row.

### Shape neck

RS – Work 13(16, 20, 24) sts, turn, leave rem sts on a holder.

WS – P2, p2tog, p to end.  
RS – K to last 4 sts, k2tog, k2.  
Rep these 2 rows once more, then WS row again. 8(11,15,19)sts.  
Work 12 rows straight.  
Cast off.  
With RS facing, leave 34(34, 36, 36)sts on holder, rejoin yarn to rem sts, k to end.  
Next Row: WS – P to last 4 sts, p2tog tbl, p2.  
Next Row: RS – K2, skpsso, k to end. Rep these 2 rows once more, then WS row again. 8(11, 15, 19)sts].  
Work 12 rows straight.  
Cast off.

### BACK

Work back to match front incorporating back neck shaping into last 6 rows as follows:  
RS – Work 13(16, 20, 24) sts, turn, leave rem sts on a holder. Dec 1 st at neck edge on next 5 rows. 8(11, 15, 19) sts]. Cast off.  
With RS facing, leave 34(34, 36, 36)sts on holder, rejoin yarn to rem sts, k to end. Dec 1 st at neck edge on next 5 rows. 8(11, 15, 19)sts. Cast off.

### SLEEVES

Using 4.00mm needles, cast on 36(36, 40, 40)sts.  
Work 3cm st st, ending on a WS row.  
Change to 5.00mm needles. Cont working in st st at the same time shape sides as follows: inc 1 st each end every 8th row, 10 times, then on foll 10th rows, twice. 60(60, 64, 64)sts, 100 shaping rows.  
Cont working straight until length (incl band) measures 44(44, 46, 46)cm, ending on a WS row.

### Shape top

Cast off 3 sts at beg next 2 rows. 54(54, 58, 58)sts.  
Next Row: RS dec – K2, k3tog, k to last 5 sts, k3tog tbl, k2. Dec as set in last row. Dec 2 sts each end every 4th row, 6 times. Work 1 row.  
Next Row: RS dec – K2, k3tog, k to last 5 sts, k3tog tbl, k2. Work 1 row. Rep last 2 rows once more. 18(18,22,22)sts.  
Cast off 4 sts at beg next 2 rows. Cast off rem 10(10, 14, 14)sts.

### MAKING UP

Press all pieces gently, except ribs, on WS using a warm iron over a damp cloth. Using backstitch join shoulder seams. Centre sleeves and join, join side and sleeve seams using edge to edge st on ribs.

### COLLAR

Using 4.00mm circular needle, with RS facing, pick up and knit 16 sts down left front, 34(34, 36, 36)sts from holder at centre front, 16 sts up right front, 6 sts down back shaping, 34(34, 36, 36) sts from holder at back neck and 6 sts up rem back neck shaping. 112(112, 116, 116)sts. Work in rounds of st st until collar measures 6cm. Cast off. Press seams.

Jo Sharp

[www.josharppatterns.com](http://www.josharppatterns.com)

### SKILL LEVEL



### WHAT YOU'LL NEED

#### Yarn

14, 15, 16, 17 balls 50g Jo Sharp Desert Garden Aran Cotton in Monet 209

#### Needles

4.00mm knitting needles  
5.00mm knitting needles  
4.00mm circular needle

#### Tension

18 sts by 24 rows over st st on 5.00mm needles to 10cm

### MEASUREMENTS

TO FIT BUST	80	90	100	110 CM
<b>FINISHED FIT</b>	<b>94</b>	<b>100</b>	<b>112</b>	<b>120 CM</b>
GARMENT LENGTH	54	54	56	56 CM
<b>SLEEVE LENGTH</b>	<b>44</b>	<b>44</b>	<b>46</b>	<b>46 CM</b>





# ARAN BEANIE

*10ply Aran knit in Cleckheaton Country*

## STITCH GUIDE

**NOTE** – This beanie is worked on smaller needles and at a firmer tension than usually recommended for this yarn.

Using set of 3.75mm double-pointed needles, cast on 132

sts and divide evenly between 3 needles. Join to work in rounds, taking care not to twist cast-on edge.

**Round 1:** \* P2, K2, rep from \* to end.

Rep last round 8 times.

**Round 10:** Rib 32, inc in next st, (rib 43, inc in next st) twice,

rib to end. 135 sts. Change to set of 4.50mm double-pointed needles.

## Beg Main Patt

**Round 1:** \* (P2, K2) twice, P2, TW, P3, K4, P3, TW, P2, MB, P4, C5F, P4, MB, P2, TW, rep from \* to end.

## SKILL LEVEL



intermediate

## WHAT YOU'LL NEED

### Yarn

3 balls 50gm  
Cleckheaton Country  
Aran 10ply in cream 4001

### Needles

4.50mm set double-pointed knitting needles  
3.75mm set double-pointed knitting needles  
Cable needle  
Wool sewing needle  
Pom-pom maker or piece of cardboard

### Tension

20.5 sts by 26 rows over stocking st, on 4.50mm needles to 10cm

### Special Abbreviations

TW = Knit into back of 2nd st on left-hand needle (taking needle behind first st), then knit first st, slipping both sts off needle tog.

C3F = Slip next 2 sts onto cable needle and leave at front of work, P1, then K2 from cable needle.

C3B = Slip next st onto cable needle and leave at back of work, K2, then P1 from cable needle.

C4F = Slip next 2 sts onto cable needle and leave at front of work, K2, then K2 from cable needle.

C5F = Slip next 2 sts onto cable needle and leave at front of work, (K2, P1), then K2 from cable needle.

MB = Make bobble – (K1, P1, K1, P1, K1) all into next st, turn, P5, turn, K5, turn, P2tog, P1, P2tog, turn, P3tog.



Cleckheaton

**Round 2 and foll alt rounds:**

Knit all knit sts and purl all purl sts as they appear.

**Round 3:** \* P2, C3F, C3B, P2, TW, P3, C4F, P3, TW, P6, C3B, P1, C3F, P6, TW, rep from \* to end.

**Round 5:** \* P3, C4F, P3, TW, P2, C3B, C3F, P2, TW, P5, C3B, P3, C3F, P5, TW, rep from \* to end.

**Round 7:** \* P3, K4, P3, TW, P2, (K2, P2) twice, TW, P4, C3B, P5, C3F, P4, TW, rep from \* to end.

**Round 9:** \* P3, C4F, P3, TW, P2, C3F, C3B, P2, TW, P3, C3B, P7, C3F, P3, TW, rep from \* to end.

**Round 11:** \* P2, C3B, C3F, P2, TW, P3, C4F, P3, TW, P2, C3B, P9, C3F, P2, TW, rep from \* to end.

**Round 13:** \* P2, (K2, P2) twice, TW, P3, K4, P3, TW, P2,

K2, P5, MB, P5, K2, P2, TW, rep from \* to end.

**Round 15:** \* P2, C3F, C3B, P2, TW, P3, C4F, P3, TW, P2, C3F, P9, C3B, P2, TW, rep from \* to end.

**Round 17:** \* P3, C4F, P3, TW, P2, C3B, C3F, P2, TW, P3, C3F, P7, C3B, P3, TW, rep from \* to end.

**Round 19:** \* P3, K4, P3, TW, P2, (K2, P2) twice, TW, P4, C3F, P5, C3B, P4, TW, rep from \* to end.

**Round 21:** \* P3, C4F, P3, TW, P2, C3F, C3B, P2, TW, P5, C3F, P3, C3B, P5, TW, rep from \* to end.

**Round 23:** \* P2, C3B, C3F, P2, TW, P3, C4F, P3, TW, P6, C3F, P1, C3B, P6, TW, rep from \* to end.

**Round 24:** As 2nd round.  
Rounds 1 to 24 incl form main patt.

Work 12 rounds.

**Shape Crown**

**Round 1:** \* P2, (K2, P2) twice, TW, P2tog, P1, K4, P1, P2tog, TW, P2tog, K2, P5, MB, P5, K2, P2tog, TW, rep from \* to end. 123 sts.

**Round 2 and foll alt rounds:** Knit all knit sts and purl all purl sts as they appear.

**Round 3:** \* P2tog, C3F, C3B, P2tog, TW, P2, C4F, P2, TW, P1, C3F, P9, C3B, P1, TW, rep from \* to end. 117 sts.

**Round 5:** \* P2, C4F, P2, TW, P1, C3B, C3F, P1, TW, P2tog, C3F, P7, C3B, P2tog, TW, rep from \* to end. 111 sts.

**Round 7:** \* P2, (K2tog) twice, P2, TW, P1, K2, P2, K2, P1, TW, P2tog, C3F, P5, C3B, P2tog, TW, rep from \* to end. 99 sts.

**Round 9:** \* P2tog, K2tog, P2tog, TW, P2tog, (K2tog)

twice, P2tog, TW, P2tog, C3F, P3tog, C3B, P2tog, TW, rep from \* to end. 66 sts.

**Round 11:** \* P1, K1, P1, K2tog, P1, K2tog, P1, K2tog, P2tog, K1, sl 1, K3tog, pssso, P2tog, K2tog, rep from \* to end. 39 sts.

**Round 12:** As 2nd round. Break off yarn, thread end through rem sts, draw up tightly and fasten off securely.

**MAKING UP**

Do not press. Using a medium pom-pom maker or 2 circles of cardboard 10cm in diameter with a 3cm hole in the centre, make a pom-pom and attach securely to crown.

**Cleckheaton Yarns**

**1800 337 032**

**www.cleckheaton.com.au**



**Yarns on Collie**

**Shop3** 17-23 Collie Street  
Fremantle WA 6160 (closed on Tuesdays)

As you enter Yarns on Collie you enter another world, an exciting world, of colour and texture. Knitting and crochet haberdashery and embroidery supplies are all here in this wonderful store.

If you want a ball of yarn, a button, a metre of elastic or just help with your project, come and see our friendly and knowledgeable staff who are always on hand to help you.

**(08) 9335 4455**

Associated with Crossways Wool & Fabrics of Subiaco.  
Email: sales@woolshop.com.au  
Visit our website: www.woolshop.com.au



**CROSSWAYS Wool & Fabrics**

**Shop 15**, Crossways Shopping Centre  
Corner of Bagot and Rokeby Road  
Subiaco WA 6008

As you enter Crossways Wool & Fabrics you enter another world, of colour and texture. Knitting and crochet haberdashery and embroidery supplies are all here in this wonderful store.

If you want a ball of yarn, a button, a metre of elastic or just help with your project, come and see our friendly and knowledgeable staff who are always on hand to help you.

**(08) 9381 4286**

Associated with 'Yarns of Collie' of Fremantle  
Email: sales@woolshop.com.au  
Visit our website: www.woolshop.com.au



**THE NORMAN LINDSAY GALLERY**

Former home of artist and writer Norman Lindsay, now displays the artist's artwork, ship models, & Magic Pudding characters.  
**Landscaped grounds for picnics, Gift shop and Café**



**Coming Events 2015**  
• Wine and Jazz 16th May  
• Exhibition: **Norman Lindsay and World War 1**  
– mid April – July

**14 Norman Lindsay Cres, Faulconbridge NSW**  
**OPEN 7 days 10am - 4pm Tel: (02) 4751 1067**  
**Website: www.normanlindsay.com.au**  
**Email: info@normanlindsay.com.au**



**NATIONAL TRUST**

# JUNIPER SWEATER AND PARTRIDGE SCARF

*A unisex sweater with simple drop shoulder shaping and V-neck with a partridge scarf*



## STITCH GUIDE

### FRONT

Using 4.50mm needles, cast on 94(104, 116, 130)sts. Work in k2, p2 rib for 4cm, ending on a WS row.

Change to 5.00mm needles. Cont working in Stocking st until bodice length (incl band) measures 40(40, 41, 41)cm, ending on a WS row.

## SKILL LEVEL



## WHAT YOU'LL NEED

### Yarn

Juniper Sweater  
10, 10, 13, 14 Jo Sharp  
Silkroad Aran Tweed  
Russet 113 or Dusk 118 or  
Licorice 119  
Partridge scarf  
4 balls 50gm Jo Sharp  
Silkroad Aran Tweed in  
Vermouth 114

### Needles

4.50mm knitting needles  
5.00mm knitting needles

### Tension

18 sts by 24 rows over  
Stocking st on 5.00mm  
needles to 10cm

### Shape armholes

Cast off 4 sts at beg next 2 rows.

**Next Row:** RS - Dec 1st each end every row 6 times\* . 74(84, 96, 110)sts.

Cont straight until bodice length (incl band) measures 49(49, 52, 52)cm, ending on a WS row.

### Shape neck

Work 37(42, 48, 55)sts, turn, leave rem 37(42, 48, 55)sts on a holder.

Work each side of neck separately.

Dec 1 st at neck edge of every row 4 times, then 1 st at neck edge every alt row 14 times. 19(24, 30, 37)sts, 32 shaping rows.

Work 1 row.

### Shape shoulders

**Next Row:** RS - Cast off 6(8, 10, 12)sts at beg next and foll alt rows, once. Work 1 row.

Cast off rem 7(8, 10, 13)sts.

With RS facing, rejoin yarn to rem sts.

Work second side to match first side, rev all shaping.

### BACK

Work as for front to \*. Cont working straight until bodice length matches front bodice to shoulder shaping (omitting front neck shaping).

### Shape shoulders and back neck

**Next Row:** RS - Cast off 6(8, 10, 12)sts, work 25(28, 30, 35) sts, turn, leave rem 43(48, 56, 63)sts on a holder.

**Next Row:** WS - Cast off 6(6, 5, 5)sts, p to end.

**Next Row:** RS - Cast off 6(8, 10, 12)sts, k to end.

**Next Row:** WS - Cast off 6(6, 5, 5)sts, p to end.

**Next Row:** RS - Cast off rem 7(8, 10, 13)sts.

Leave 12(12, 16, 16) centre sts on a holder.

With RS facing, rejoin yarn to rem sts.

**Next Row:** RS - Cast off 6(6, 5, 5)sts, k to end.

**Next Row:** WS - Cast off 6(8, 10, 12)sts, p to end.

**Next Row:** RS - Cast off 6(6, 5, 5)sts, k to end.

**Next Row:** WS - Cast off 6(8, 10, 12)sts, p to end.

Cast off rem 7(8, 10, 13)sts.

### SLEEVES

Using 4.50mm needles, cast on 48(48, 52, 52)sts.

Work in k2, p2 rib for 4cm , ending on a WS row.

Change to 5.00 mm needles.

Cont. working in Stocking st, shaping sides as follows:

inc 1 st each end next row,

then 1 st at each end foll

5th rows 0(0, 20, 20) times,

then foll 6th rows 16(16, 0,

0) times. 82(82, 94, 94)sts,

97(97,101,101) shaping rows.

Work straight until length (incl. band) measures 47(47,

49, 49)cm, ending on a

WS row.

### Shape top

RS - Cast off 4 sts at beg of next 2 rows.

**Next Row:** RS - Dec 1 st at each end every row 6 times.

62(62, 74, 74)sts.

Cast off.

### MAKING UP

Press all pieces gently on

WS using a warm iron over a damp cloth.

Using Backstitch join right shoulder seam.



### NECKBAND

With RS facing, using 4.50mm needles, pick up and knit 32(32, 34, 34) sts down left side of neck, place marker on right needle, pick up and knit 32(32, 34, 34) sts up right side of neck, then 12(12, 10, 10) sts across back neck, then 12(12, 16, 16) sts from holder, then 12(12, 10, 10) sts across remainder of back neck. 100(100, 104, 104) sts.

**Row 1:** WS - (P2, k2) rep to within 2 sts of marker, P2tog tbl, slip marker to right needle, P2tog tbl, (p2, k2) rep to end. This row sets rib. Decreasing 1 st each side of marker as set, work 6 rows rib.

Cast off rem sts, still decreasing at centre front.

Join left shoulder and neckband seam.

Set in sleeves, join side and sleeve seams.

### PARTRIDGE SCARF SCARF

Using 5.00mm needles, cast on 45 sts. Work in Garter st (knit all rows) until length measures 120cm. Cast off.

### FRINGE

Cut strands of yarn 10cm in length. Using 4 strands together, fold in half. Insert crochet hook just above cast on (or off) edge of scarf from back to front, catch the folded strands of yarn with hook and pull it through the knitting. Insert the ends of yarn into loop and pull through to tighten. Cont in this way until edge is sufficiently covered with fringe. Trim ends to even lengths.

Repeat at other end of scarf.

Jo Sharp

[www.josharppatterns.com](http://www.josharppatterns.com)

### MEASUREMENTS

SIZE	A	B	C	D
<b>TO FIT CHEST</b>	<b>80-90</b>	<b>90-100</b>	<b>100-110</b>	<b>110-120CM</b>
FINISHED FIT	102	114	126	142CM
<b>GARMENT LENGTH</b>	<b>65</b>	<b>65</b>	<b>68</b>	<b>68CM</b>
SLEEVE LENGTH	47	47	51	51CM
<b>SCARF</b>	<b>LENGTH 120CM</b>	<b>WIDTH 25CM</b>		

# HAT AND BUTTONED SHORT SCARF

Design by Gitta Schrade for Naturally Yarns

## SKILL LEVEL



intermediate

## WHAT YOU'LL NEED

### Yarn

1 ball 50gm Waikiwi Prints 4ply in shade #471 - hat  
2 balls 50gm Waikiwi Prints 4ply in shade #471 - scarf  
3 Incomparable Buttons: L96

### Needles

3.25mm set of double pointed needles  
3.00mm knitting needles  
3.25mm knitting needles

### Tension

28 sts by 36 rows over Stocking Stitch on 3.25mm needles to 10cm.

### Special abbreviations

psso - pass slipped stitch over;  
skp - slip 1 stitch, knit 1 stitch, pass the slipped stitch over;  
M1 - k into back of strand between stitch just worked and next stitch.  
togtbl - knit or purl stated number of stitches together through back of loops.

## GETTING STARTED HAT (WORKED FROM TOP DOWN)

Starting out with double pointed needles due to small amount of stitches; however change to straight needles when enough stitches on needle to do so.

## WORKING PATTERN

With 3.25mm double-pointed needles, cast on 7 sts and divide over 2 or 3 needles.

**Row 1:** RS - \*K1, M1; rep from \* to last st, k1. 13 sts.

**Row 2 and all other WS rows:** Purl.

**Row 3:** RS - \*K2, M1; rep from \* to last st, k1. 19 sts.

**Row 5:** \*K3, M1; rep from \* to last st, k1. 25 sts.

**Row 7:** \*K4, M1; rep from \* to last st, k1. 31 sts.

**Row 9:** \*K5, M1; rep from \* to last st, k1. 37 sts.

**Row 11:** \*K6, M1; rep from \* to last st, k1. 43 sts.

**Row 13:** \*K7, M1; rep from \* to last st, k1. 49 sts.

**Row 15:** \*K8, M1; rep from \* to last st, k1. 55 sts.

**Row 17:** \*K9, M1; rep from \* to last st, k1. 61 sts.

**Row 19:** \*K10, M1; rep from \* to last st, k1. 67 sts.

**Row 21:** \*K11, M1; rep from \* to last st, k1. 73 sts.

**Row 23:** \*K12, M1; rep from \* to last st, k1. 79 sts.

**Row 25:** \*K13, M1; rep from \* to last st, k1. 85 sts.

**Row 27:** \*K14, M1; rep from

to last st, k1. 91 sts.

**Row 29:** \*K15, M1; rep from \* to last st, k1. 97 sts.

Cont in this manner until the number of sts between M1's is 23 and a total of 145 sts on needle to fit an average size adult head. (Cont to inc if desired fit has not been reached yet.)

**Next Row:** WS - Purl.

Mark centre of last row. Stst straight for 28 rows from marker.

Change to 3.00mm needles.

Stst further 20 rows.

Cast off loosely using 3.25mm needles.

Break yarn, leaving longer end, join back seam.

## BUTTONED SHORT SCARF

Using 3.25mm straight needles, cast on 45 sts.

**Row 1:** RS - K2, p1; \*k1, p1; rep from \* to last 2 sts, k2.

**Row 2:** P2, k1; \*p1, k1; rep from \* to last 2 sts, p2.

**Row 3:** K3; \*p1, k1; rep from \* to last 2 sts, k2.

**Row 4:** P3; \*k1, p1; rep from \* to last 2 sts, p2.

Rep these 4 rows until piece measures 76cm from beg, end with a WS row.

## Shape Tip and Place Buttonholes

**Next Row:** RS - K2, skp, patt 3, k2tog, yo twice, skp, patt to last 11 sts, k2tog, yo twice, skp, patt 3, k2tog, k2. 43 sts.

**Next Row:** P2, p2tog, patt to last 4 sts, p2togtbl, p2. 41 sts.

**Next Row:** RS - K2, skp, patt to last 4 sts, k2tog, k2. 39 sts.

**Next Row:** P2, p2tog, patt to last 4 sts, p2togtbl, p2. 37 sts.

Cont to dec in this manner until 21 sts rem, end with a WS row.

**Next Row:** RS - K2, skp, patt 5 sts, k2tog, yo twice, skp, patt 4 st, k2tog, k2. 19 sts.

**Next Row:** P2, p2tog, patt to last 4 sts, p2togtbl, p2. 17 sts.

**Next Row:** K2, skp, patt to last 4 sts, k2tog, k2. 15 sts.

**Next Row:** P2, p2tog, patt to last 4 sts, p2togtbl, p2. 13 sts.

**Next Row:** K2, skp, patt to last 4 sts, k2tog, k2. 11 sts.

**Next Row:** P2, p2tog, patt to last 4 sts, p2togtbl, p2. 9 sts.

**Next Row:** RS - K2, skp, patt 1 st, k2tog, k2. 7 sts.

**Next Row:** P3, p2togtbl, p2. 6 sts.

**Next Row:** K3togtbl, k3tog. 2 sts.

**Next Row:** P2tog, fasten off.

## MAKING UP

Sew on buttons (using photo as placement guide).

**Wentworth Distributors NZ Ltd**  
Free phone AU: 1800 150 542  
Free phone NZ: 0800 738 998  
[www.naturallyyarnsnz.com](http://www.naturallyyarnsnz.com)



**MEASUREMENTS**

HAT - TO FIT MEDIUM SIZE ADULT HEAD

SCARF - LENGTH APPROX 81CM WIDTH APPROX 15CM

# CHRISTINA SCARF

*A textured rib scarf*



## MEASUREMENTS

WIDTH 35CM X 180CM LENGTH

## GETTING STARTED

Scarf is worked using 4.00mm and 8.00mm needles alternately throughout. All Knit sts are worked through back of loop.

### Rib Pattern

Row 1: RS – Using 4mm

needles \*k1tbl, P1, rep from \* to end.

Row 2: using 8.00mm needle \*k1tbl, P1, rep from \* to end. Rep rows 1 and 2 throughout.

## WORKING PATTERN

Using 8.00mm needles cast on 70sts

Work in rib pattern until work measures 180cm ending with a WS row. Cast off.

### The Wool Inn

Shop 14 NK Centre  
450 High St, Penrith  
Ph: 02 4732 2201

[www.the-wool-inn.com.au](http://www.the-wool-inn.com.au)

## SKILL LEVEL



intermediate

## WHAT YOU'LL NEED

### Yarn

180gm Noro Janome shade 1 or  
250gm Noro Silk Garden Lite

### Needles and tools

4.00mm knitting needles  
8.00mm knitting needles

### Tension

18sts by 18 rows over rib pattern on 4.00mm needles to 10cm



# GLOSSARY

## BEGINNER'S TOOL KIT

### PINS

Plastic head pins are useful for checking tension and blocking out items. Pins with coloured heads are best because they do not get lost in your work.



### ROW COUNTER

A row counter is helpful for keeping track of rows worked, particularly where increases, decreases or other kinds of patterning occur.



### KNITTING IN ELASTIC

Elastic yarn prevents sagging in cuffs, collars and waists. You can work it in with knitting yarn on knitted or crocheted garments.



### KNITTING NEEDLES

Knitting needles are made from plastic, aluminium or wood and come in varying lengths and widths. Straight needles come in pairs and doublepointed needles come in sets of four.



### KNITTING BAG

A knitting bag is essential for those who like to knit 'on the go'. Not only is it a practical way to keep all your knitting paraphernalia together, it also helps keep the yarn clean and tangle-free.

### CIRCULAR KNITTING NEEDLES

Circular needles have two working ends joined by a thin nylon wire. They are more balanced than straight needles and allow the weight of your work to rest in your lap.



### KNITTER'S NEEDLES

Knitter's needles need to have a large eye and a blunt point so they do not split stitches when sewing up your knitting.



### STITCH HOLDER

A stitch holder is used to secure stitches not in use. You can also use safety pins for holding a small number of stitches.



### TAPE MEASURE

A basic tape measure is essential for checking your garment measurements.



### STITCH GAUGE

A stitch gauge is a flat piece of metal or plastic with a ruler marked on one side and/or a window cut out in the centre. It allows you to mark and measure easily and accurately.

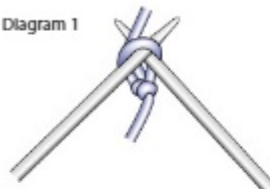
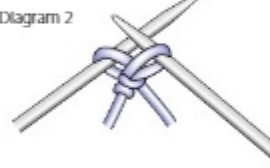
<p><b>Diagram 1</b></p>  <p><b>Diagram 2</b></p> 	<p><b>CASTING ON</b></p> <p>Casting on is creating a row of loops on a knitting needle to form the base row for your knitting. One of the most popular methods of casting on is the cable cast on. Form a slipknot about 25cm away from the end of the yarn.</p> <p>Place the slipknot on a knitting needle and pull gently to secure. Hold this needle in your left hand. Insert the right hand needle through the slip knot. Pass the yarn over the point of the right hand needle (see Diagram 1).</p> <p>Pull a loop through the slip knot with the right hand needle (see Diagram 2). Place this loop on the left hand needle and gently pull the yarn to secure the stitch. For the remaining cast on stitches, insert the right hand needle between the slip knot and the first stitch on the left hand needle. Wind the yarn around the point of the right hand needle. Draw a loop through and place this loop on the left hand needle. Continue in this manner until you have cast on the desired number of stitches.</p>
---	---

**KNIT STITCH**

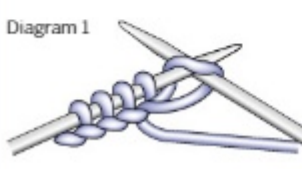
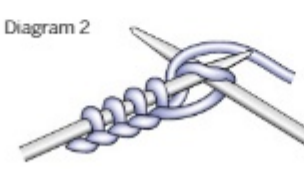
<p><b>Diagram 1</b></p>  <p>Once you have cast on, you then knit into the stitches you have made to form the knitted fabric. Hold the needle with the cast on stitches in your left hand, with the loose yarn at the back of your work. Insert the right hand needle from left to right through the front of the first stitch on the left hand needle (see Diagram 1). Wind the yarn from left to right over the point of the right hand needle (see Diagram 2). Draw the</p>	<p><b>Diagram 2</b></p>  <p>yarn through the stitch to form a new stitch on the right hand needle. Slip the original stitch off the left hand needle, keeping the new stitch on the right hand needle. To knit a row, repeat these steps until all the stitches have been transferred from the left hand needle to the right hand needle. Turn your work, transferring the needle with the stitches on into your left hand to work the next row.</p>
--	---

**PURL STITCH**

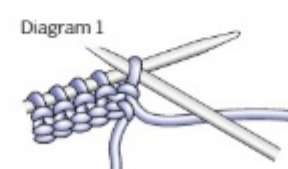
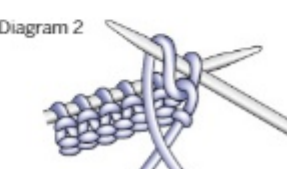
<p><b>Diagram 1</b></p>  <p>The purl stitch is basically the reverse of the knit stitch. Hold the needle with the stitches on in your left hand, with the loose yarn at the front of your work. Insert the right hand needle from right to left into the front of the first stitch on the left hand needle (see Diagram 1). Wind the yarn from right to left over the point of the right hand needle (see Diagram 2). Draw the yarn through the</p>	<p><b>Diagram 2</b></p>  <p>stitch to form a new stitch on the right hand needle. Slip the original stitch off the left hand needle, keeping the new stitch on the right hand needle. To purl a row, repeat these steps until all the stitches have been transferred from the left hand needle to the right hand needle. Turn your work, transferring the needle with the stitches on into your left hand to work the next row.</p>
---	--

**CASTING OFF**

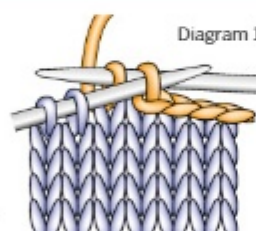
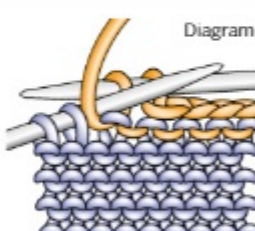
<p><b>KNITWISE</b></p> <p>Knit two stitches. Use the point of the left hand needle to lift the first stitch on the right hand needle over the second, and drop it off the needle. Knit the next stitch on the left hand needle so that there are two stitches on the right hand needle again, and repeat. Continue in this manner until all the stitches have been worked off the left hand needle and only one stitch remains on the right hand needle. Cut the yarn, leaving a tail and thread the yarn through the loop and pull it firmly to fasten off.</p> <p><b>Diagram 1</b></p> 	<p><b>PURLWISE</b></p> <p>Purl two stitches. Use the point of the left hand needle to lift the first stitch on the right hand needle over the second, and drop it off the needle. Purl the next stitch on the left hand needle so that there are two stitches on the right hand needle again, and repeat. Continue in this manner until all the stitches have been worked off the left hand needle and only one stitch remains on the right hand needle. Secure this last stitch as described in casting off knitwise.</p> <p><b>Diagram 2</b></p> 
--	--

## SUBSTITUTING YARNS

If you substitute or spin a yarn for a project, you can compare the weight of the yarn to the project yarn by comparing wraps per inch. Wrap your yarn around a ruler for one inch and count the number of wraps. If you have more wraps per inch than the project yarn, your yarn is too thin; if you have fewer wraps per inch than the project yarn, your yarn is too thick.



## KNITTING TENSION

Checking your knitting tension, that is, the tightness or looseness of your knitting, is important. To check your tension, cast on 30 stitches using the recommended needle size. Work in the pattern until your work measures 10cm from the cast on edge then cast off. You now have a "swatch". Measure your tension by placing a ruler over your swatch and counting the number of stitches

across and rows down (including fractions of stitches and rows) in 10cm. Repeat these measurements two to three times on a different parts of the swatch to check your measurements. If you have more stitches and rows than called for in the instructions, you should use larger needles; if you have fewer, use smaller needles. Check your tension again before starting your project.

## PROVISIONAL CAST ON (INVISIBLE CAST ON)

Place a loose slipknot on the needle in your right hand. Hold the waste yarn next to the slipknot and around your left thumb. Hold your working yarn over your left index finger.

\*Bring the needle forward under the waste yarn, over the working yarn, grab a loop of working yarn (Diagram

1), then bring the needle to the front, over both yarns, and grab a second loop (Diagram 2). Repeat from \* until you have the desired number of stitches on your needle. When you're ready to work in the opposite direction, pick out the waste yarn to expose the live stitches.

Diagram 1



Diagram 2



Diagram 1

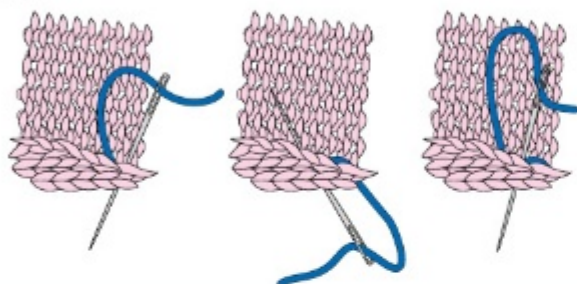

## BACKSTITCH

This is the stitch most commonly used for joining knitted garments. With the right sides of your work together, pin the knitted fabric together with the edges even. The seam should be sewn one full stitch from the end of the row. One stitch should be worked over every row. Thread the yarn needle. Insert the needle through both layers and sew two stitches to the left then one stitch back to the right. Keep stitches at an even distance. Continue working from right to left in this circular motion. (Diagram 1)

## TASSELS

Cut yarn twice the length of your desired tassel plus a bit extra for the knot. According to the desired thickness of the tassel, select a number of lengths of yarn. Fold the lengths of yarn in half over a crochet hook. On the wrong side, insert the crochet hook from the front to the back through the edge of the work. Grab the yarn and pull through and tighten. Trim the ends to the same length.

## KNOTTED FRINGE

After working a tassel, take one half of the strands from each tassel and knot them with half the strands from the neighbouring tassel. Trim.



### CROCHET CHAIN

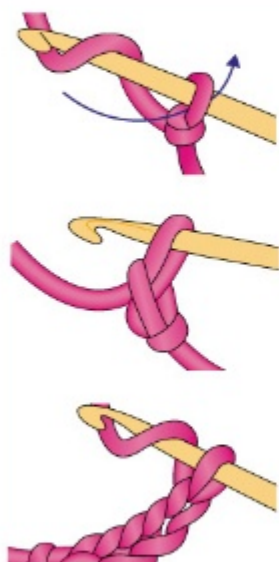

Make a slip knot on your hook. Pass the yarn over the hook and catch it with the hook and draw it through the loop on the hook. Repeat, drawing yarn through the last loop formed.

### DOUBLE CROCHET (DC) (US SINGLE CROCHET SC)

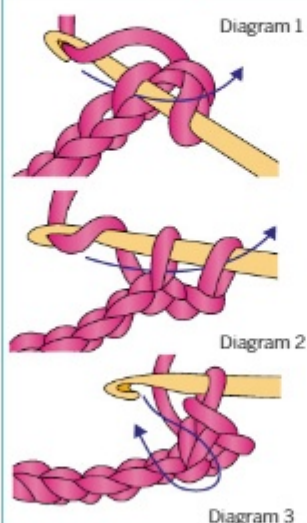

Insert the hook through the top two loops of a stitch. Pass the yarn over the hook and draw up a loop so that you have two loops on the hook (Diagram 1). Pass the yarn over the hook and draw through both loops on the hook (Diagram 2). Continue in the same way, inserting the hook into each stitch (Diagram 3).

### TREBLE CROCHET (TR) (US DOUBLE CROCHET DC)

Diagram 1

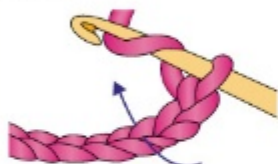

Pass the yarn over the hook. Insert the hook through the top two loops of a stitch (Diagram 1). Pass the yarn over the hook and draw up a loop so that you have three loops on the hook (Diagram 2). Pass the yarn over the hook and draw it through the first two loops on the hook, pass the yarn over the hook and draw through the remaining two loops. Continue in the same way, inserting the hook into each stitch (Diagram 3).



### HALF TREBLE CROCHET (HTR) (US HALF DOUBLE CROCHET HDC)

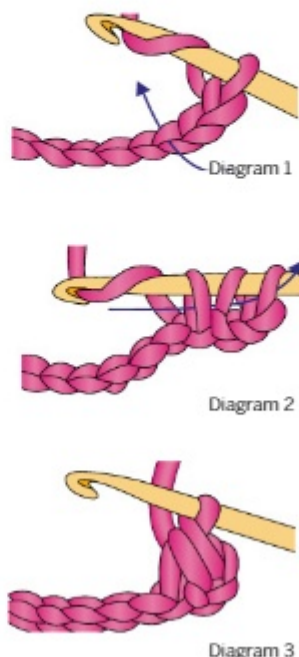

Pass the yarn over the hook. Insert the hook through the top two loops of a stitch (Diagram 1). Pass the yarn over the hook and draw up a loop so that there are three loops on the hook (Diagram 2). Draw through all three loops on the hook (Diagram 3).

### SLIP STITCH CROCHET (SL ST)



Insert your hook into the stitch. Yarn over the hook and draw the loop through the stitch and loop onto the hook.

### I-CORD

With double pointed needles, cast on the desired number of stitches. \*Without turning the needle, slide the stitches to the other end of the needle, pull the yarn around the back and knit the stitches as usual. Repeat from \* until your work measures the desired length

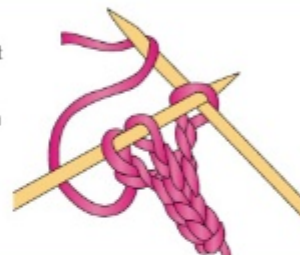

### PICKING UP DROPPED STITCHES

A dropped stitch can be picked up using a crochet hook and don't be put off by stitches that have unraveled several rows down into the work. To pick up knit stitches, insert the crochet hook into the dropped stitch, draw through the bar lying above the dropped stitch and pull it through the loop of the dropped stitch.

## KNITTING ABBREVIATIONS

<b>Alt</b> - Alternate; alternately	<b>P2tog</b> - Purl two stitches together
<b>Beg</b> - Begin; begins; beginning	<b>Patt</b> - pattern
<b>CC</b> - Contrasting colour	<b>PssO</b> - Pass slipped stitch over previous stitch
<b>Ch</b> - Chain	<b>Pb</b> - Purl through the back of the stitch
<b>Cm</b> - Centimetre/s	<b>Pwise</b> - Purlwise
<b>CO</b> - Cast on	<b>Rem</b> - Remaining
<b>Cont</b> - Continue; continuing	<b>Rep</b> - Repeat
<b>Dec</b> - Decrease; decreasing	<b>Sl 1</b> - Slip one stitch across from left needle to right needle without knitting it.
<b>Dk</b> - Double Knitting	<b>Sl 1 Purlwise</b> - Slip next stitch off left needle onto right as if to purl the stitch.
<b>Foll</b> - Follow; follows; following	<b>Sts</b> - Stitches
<b>G st</b> - Garter stitch. If knitting back and forth, knit every row. If knitting circularly, one round knit, next round purl.	<b>St st</b> - Stocking stitch. If knitting back and forth, one row knit, next row purl. If knitting circularly, knit each round.
<b>Inc</b> - Increase; increasing	<b>SSK</b> - Slip, slip knit. Makes a left slanting decrease.
<b>Incl</b> - Including	Slip two stitches knitwise, on at a time from the left to the right needle, then knit them together through their backs.
<b>K</b> - Knit	<b>Tog</b> - Together
<b>K1</b> - Knit one stitch	<b>WS</b> - Wrong side
<b>K2tog</b> - Knit two stitches together	<b>Ybk</b> - Yarn back
<b>Kb</b> - Knit through the back of the stitch	<b>Y fwd</b> - Yarn forward - bring yarn under the needle, then over to the knitting position again, creating a new stitch.
<b>Kwise</b> - Knitwise	<b>Yo</b> - Yarn over.
<b>M</b> - Make one stitch	
<b>MC</b> - Main colour. When two or more colours are used, the main colour is the yarn that is dominant.	
<b>P</b> - Purl	
<b>P1</b> - Purl one stitch	

## CROCHET TERMS &amp; ABBREVIATIONS

approx	approximately		together or skipping the stitches.
beg	begin(ning)		
CC	contrast colour	foll	follow(s)(ing)
ch	chain(s)	gm	grams
cm	centimetre(s)	htr	half treble crochet (US half double crochet hdc)
cont	continue(ing)		
dc	double crochet (US single crochet sc)	inc	increase(ing). Add stitches in a row by working in extra stitches into a chain or between the stitches.
dec	decrease(ing). Reduce the stitches in a row by either working the stitches		

## CROCHET TERMS &amp; ABBREVIATIONS CONTINUED ...

LH	left-hand	sl st	slip stitch
lp(s)	loop(s)	sp(s)	space(s)
m	metre(s)	st(s)	stitch(es)
MC	main colour	t-ch	turning chain
mm	millimetre	tog	together
oz	ounces	tr	treble (US dc)
pat(s)	pattern(s)	WS	wrong side
pm	place markers. Place or attach a loop of contrast yarn or a stitch marker as indicated.		work even/work straight. Continue in the pattern without increasing or decreasing
rem	remaining	yd	yards
rep	repeat	yo	yarn over. Wrap the yarn around the hook
rnd(s)	round(s)	*	repeat the directions following * as many times as indicated
RH	right-hand		
RS	right side		
sk	skip, miss		

## CROCHET HOOKS

METRIC	US
.60mm	14 steel
.75mm	12 steel
1.00mm	10 steel
1.50mm	6 steel
1.75mm	5 steel
2.00mm	B/1
2.5mm	C/2
3.00mm	D/3
3.50mm	E/4
4.00mm	F/5
4.50mm	G/6
5.00mm	H/8
5.50mm	I/9
6.00mm	J/10
6.50mm	K
7.00mm	K/10.5
	P
	Q
	S

## KNITTING NEEDLES

METRIC	UK	US
2mm	14	0
2.25mm	13	1
2.5mm		
2.75mm	12	2
3mm	11	
3.25mm	10	3
3.5mm		4
3.75mm	9	5
4mm	8	6
4.5mm	7	7
5mm	6	8
5.5mm	5	9
6mm	4	10
6.5mm	3	10.5
7mm	2	
7.5mm	1	
8mm	0	11
9mm	00	13
10mm	000	15

## © Creative Knitting

All work in Creative Knitting is protected by copyright. A single pattern or chart may be reproduced for personal, nonprofit use. Patterns and charts may not be reproduced to sell or distribute to others. Patterns may not be reproduced on letterhead, with another designers name attached or on the internet. Patterns may not be reproduced for classes or groups without the express permission of the publisher. Items produced using patterns may not be sold with any name other than that of the pattern designer. Contact Woodlands Publishing Pty Ltd for further information on copyright.



Quick & easy scarf yarns  
from Katia to make in  
one night!

Visit [Katia.com](http://Katia.com) for free patterns on Park Avenue, Ronda, Ondas and Aloha with free tutorials.

View the Katia website - [www.katia.com](http://www.katia.com) to see collection, contact Texyarns on (03) 9427 9009 or email [info@texyarns.com](mailto:info@texyarns.com) for your nearest stocklist.

